



**WALL MOUNTED TYPE FAN COIL
UNIT SERVICE MANUAL**



(GC201411-I)





CONTENTS

PRODUCT	2
1 MODELS LIST	2
2 NOMENCLATURE OF THE UNIT	4
3 FUNCTION.....	4
4 PRODUCT DATA	5
CONTROL	14
1 WIRELESS REMOTE CONTROLLER	14
2 OPERATION OF WIRELESS REMOTE CONTROL	15
3 OPERATION OF WIRELESS REMOTE CONTROL	15
4 OPERATION OF WIRELESS REMOTE CONTROL	16
5 CHANGING BATTERIES AND NOTICES.....	16
6 REMOTE CONTROLLER YAP1F.....	17
7 WIRED CONTROLLER OPERATION	21
INSTALLATION	35
1 INSTALLATION OF THE UNIT	35
2 INSTALLATION DIMENSION DIAGRAM.....	36
3 INSTALL THE UNIT	37
MAINTENANCE	41
1 TROUBLESHOOTING.....	41
2 MAINTENANCE INSTRUCTIONS.....	42
3 WIRING DIAGRAMS	43
4 EXPLODED VIEWS AND SPARE PART LISTS	47

PRODUCT

PRODUCT 1 MODELS LIST

Model Name	Cooling Capacity	Product Code	Air Flow	Power Supply	Remarks
	(W)		(m ³ /h)	(V,Ph,Hz)	
FP-51BWA2/A-K	1500	EM55000240	450	220-240V~50Hz	
FP-85BWA2/A-K	2500	EM55000250	650		
FP-51BWA2/A-K(E)	1400	EM55002310	450		
FP-85BWA2/A-K(E)	3100	EM55002340	650		
FP-34BA2/D-K	2000	EM55001810	360		
FP-51BA2/D-K	2500	EM55001820	550		
FP-68BA2/D-K	3600	EM55001830	680		
FP-85BA2/D-K	4200	EM55001840	850		
FP-34BA2/D-K(E)	2000	EM55002370	360		
FP-51BA2/D-K(E)	2300	EM55002410	550		
FP-68BA2/D-K(E)	3600	EM55002450	680		
FP-85BA2/D-K(E)	4000	EM55002490	850		
FP-51BWA3/A-K	1500	EM55001430	450		
FP-85BWA3/A-K	2400	EM55001510	650		
FP-51BWA3/A-K(E)	1400	EM55002320	450		
FP-85BWA3/A-K(E)	3100	EM55002350	650		
FP-34BA3/D-K	2000	EM55002000	360		
FP-51BA3/D-K	2500	EM55002010	550		
FP-68BA3/D-K	3600	EM55002020	680		
FP-85BA3/D-K	4200	EM55002030	850		
FP-34BA3/D-K(E)	2000	EM55002380	360		
FP-51BA3/D-K(E)	2300	EM55002420	550		
FP-68BA3/D-K(E)	3600	EM55002460	680		
FP-85BA3/D-K(E)	4000	EM55002500	850		
FP-34BA3/B-K	1850	EM55001720	360	220-240V~50Hz	
FP-51BA3/B-K	2650	EM55001730	510		
FP-68BA3/B-K	3500	EM55001750	680		
FP-85BA3/B-K	4550	EM55001740	830		
FP-34BB3/A-K	2300	EM55001180	360	220-240V~50Hz	
FP-51BB3/A-K	2900	EM55001260	550		
FP-68BB3/A-K	3800	EM55001340	680		
FP-85BB3/A-K	4800	EM55001410	850		

FP-34BA4/D-K	2000	EM55002040	360	220-240V~50Hz	
FP-51BA4/D-K	2500	EM55002050	550		
FP-68BA4/D-K	3600	EM55002060	680		
FP-85BA4/D-K	4200	EM55002070	850		
FP-34BA4/D-K(E)	2000	EM55002390	360		
FP-51BA4/D-K(E)	2300	EM55002430	550		
FP-68BA4/D-K(E)	3600	EM55002470	680		
FP-85BA4/D-K(E)	4000	EM55002510	850		
FP-34BA5/D-K	2000	EM55002080	360	220-240V~50Hz	
FP-51BA5/D-K	2500	EM55002090	550		
FP-68BA5/D-K	3600	EM55002100	680		
FP-85BA5/D-K	4200	EM55002110	850		
FP-34BA5/D-K(E)	2000	EM55002400	360		
FP-51BA5/D-K(E)	2300	EM55002440	550		
FP-68BA5/D-K(E)	3600	EM55002480	680		
FP-85BA5/D-K(E)	4000	EM55002520	850		
FP-85BA2/A-D	5400	EM55001590	1000	208-230V~60Hz	
FP-34BA2/B-D	2100	EM55000320	360		
FP-51BA2/B-D	2700	EM55000330	550		
FP-68BA2/B-D	3600	EM55000340	680		
FP-85BA2/B-D	4200	EM55000350	850		
FP-102BA2/B-D	5400	EM55000360	1000		
FP-34BA3/B-D	2100	EM55001760	360	208-230V~60Hz	
FP-51BA3/B-D	2700	EM55001800	550		
FP-68BA3/B-D	3600	EM55001770	680		
FP-85BA3/B-D	4200	EM55001780	850		
FP-102BA3/B-D	5400	EM55001790	1000		
FP-34BA5/B-D	2100	EM55001890	360	208-230V~60Hz	
FP-51BA5/B-D	2700	EM55001900	550		
FP-68BA5/B-D	3600	EM55001910	680		
FP-85BA5/B-D	4200	EM55001920	850		
FP-102BA5/B-D	5400	EM55001930	1000		

FPD-34BB4/A-K	2200	EM55002580	340	220-240V~50Hz	
FPD-51BB4/A-K	2700	EM55002600	510		
FPD-68BB4/A-K	3600	EM55002590	680		
FPD-85BB4/A-K	4300	EM55002610	850		

2 NOMENCLATURE OF THE UNIT

FP	□	-	□	□	□	/	□	-	□	□
1	2		3	4	5		6		7	8

NO.	Description	Options
1	Fan coil	
2	Choice type	D indicates a direct-current motor
3	Air flow volume	Number×10m ³ /h
4	Structure type	Mounted-B Wall, mounted with water valve-BW
5	Front panel code	One letter +one number
6	Design Sequence	Arranged by A, B,C...
7	Power code	K-220-240V~ 50Hz, D-208-230V~ 60Hz
8	Sales territory	(E) Models applicable to EU

3 FUNCTION

Function		Fan Coil Unit Service Manual for Evaluation
For Comfortable Air Conditioning	Cooling	YES
	Heating	YES
	Dehumidify	YES
	Air Flow	YES
	Auto Swing	YES
	Sleep and Auto	YES
	With Access Control System	Optional
	Central Control	Optional
	Wired Controller	Optional
	Long Distance Control	Optional
	Timer	YES
	Energy Saving	YES
	Anti Cold Air	YES
	Anti Heat Air	YES
	Waste Heat Blow	YES
	Memory	YES
	Self Diagnosis	YES
Alarming	YES	

4 PRODUCT DATA

Model			FP-34BB3/A-K(E)	FP-51BB3A-K(E)	FP-68BB3A-K(E)	FP-85BB3/A-K(E)
Product Code			EM55002530	EM55002540	EM55002550	EM55002560
Air flow volume	High	m ³ /h	360	550	680	850
		CFM	212	324	400	500
	Medium	m ³ /h	322	413	591	708
		CFM	189	242	347	416
	Low	m ³ /h	282	367	532	616
		CFM	166	215	312	362
Capacity	Cooling	W	1800	2400	3500	4600
	Heating	W	2300	2600	3700	4900
Power system	Type	V-Ph-Hz	220-240V~ 50Hz			
	Input	W	36	42	51	65
Water system	Water flow volume	m ³ /h	0.36	0.43	0.61	0.78
		GPM	1.59	1.90	2.69	3.44
	Pressure drop	kPa	18	25	52	62
		Ft·WG	5.90	8.20	17.06	20.34
Coil	Type	Aluminum fin-copper tube				
	Operating pressure	MPa	≤1.6MPa	≤1.6MPa	≤1.6MPa	≤1.6MPa
Motor	Type	FN20J-PG			FN20V-PG	
	Capacitor	uF	1	1	1.5	1.5
	Power output	W	20			
Sound pressure level		dB(A)	35	40	43	48
Connection pipe size	Water inlet & outlet	inch	1/2"			
	Condensing water drain	mm	15.6			
Outline dimension (W×D×H)		mm	845×180×275			940×200×298
Package dimension (W×D×H)		mm	915×255×355			1010×285×380
Net weight		kg	10			12
Gross weight		kg	12.5			16
Loading quantity	20'GP		365			290
	40'GP		765			595
	40'HQ		850			671
Standard wireless remote controller			YB1FA			

Model		FP-51BWA2/A-K(E) FP-51BWA3/A-K(E)	FP-85BWA2/A-K(E) FP-85BWA3/A-K(E)	
Product Code		EM55002310 EM55002320	EM55002340 EM55002350	
Air flow volume	High	m ³ /h	450	650
		CFM	265	382
	Medium	m ³ /h	383	560
		CFM	225	329
	Low	m ³ /h	323	490
		CFM	190	288
Capacity	Cooling	W	1400	3100
	Heating	W	2000	3300
Power system	Type	V-Ph-Hz	220-240V~ 50Hz	
	Input	W	43	69
Water system	Water flow volume	m ³ /h	0.28	0.61
		GPM	1.23	2.72
	Pressure drop	kPa	20	53
		Ft·WG	6.56	17.38
Coil	Type		Aluminum fin-copper tube	
	Operating pressure	MPa	≤1.6MPa	≤1.6MPa
Motor	Type		FN20J-PG	FN20V-PG
	Capacitor	uF	1	1.5
	Power output	W	20	20
Sound pressure level		dB(A)	42	50
Connection pipe size	Water inlet & outlet	inch	1/2"	
	Condensing water drain	mm	15.6	
Outline dimension (W×D×H)		mm	845×180×275	940×200×298
Package dimension (W×D×H)		mm	915×255×355	1010×285×380
Net weight		kg	11	13
Gross weight		kg	14	17
Loading quantity	20'GP		365	290
	40'GP		765	595
	40'HQ		850	671
Standard wireless remote controller		YB1FA		

Model		FP-34BA2/D-K(E) FP-34BA3/D-K(E) FP-34BA4/D-K(E) FP-34BA5/D-K(E)	FP-51BA2/D-K(E) FP-51BA3/D-K(E) FP-51BA4/D-K(E) FP-51BA5/D-K(E)	FP-68BA2/D-K(E) FP-68BA3/D-K(E) FP-68BA4/D-K(E) FP-68BA5/D-K(E)	FP-85BA2/D-K(E) FP-85BA3/D-K(E) FP-85BA4/D-K(E) FP-85BA5/D-K(E)		
Product Code		EM55002370 EM55002380 EM55002390 EM55002400	EM55002410 EM55002420 EM55002430 EM55002440	EM55002450 EM55002460 EM55002470 EM55002480	EM55002490 EM55002500 EM55002510 EM55002520		
Air flow volume		High	m ³ /h	360	550	680	850
			CFM	212	324	400	500
		Medium	m ³ /h	322	413	591	708
			CFM	189	242	347	416
		Low	m ³ /h	282	367	532	616
			CFM	166	215	312	362
Capacity	Cooling	W	2000	2500	3600	4000	
	Heating	W	2300	2800	4100	4500	
Power system	Type	V-Ph-Hz	220-240V~ 50Hz				
	Input	W	50	50	60	66	
Water system	Water flow volume	m ³ /h	0.4	0.45	0.6	0.7	
		GPM	1.76	1.98	2.65	3.09	
	Pressure drop	kPa	18	25	52	60	
		Ft-WG	5.90	8.20	17.06	19.68	
Coil	Type	Aluminum fin-copper tube					
	Operating pressure	MPa	≤1.6MPa	≤1.6MPa	≤1.6MPa	≤1.6MPa	
Motor	Type	FN20J-PG			FN20V-PG		
	Capacitor	uF	1	1	1.5	1.5	
	Power output	W	20				
Sound pressure level		dB(A)	35	40	43	48	
Connection pipe size	Water inlet & outlet	inch	1/2"				
	Condensing water drain	mm	15.6				
Outline dimension (W×D×H)		mm	845×180×275			940×200×298	
Package dimension (W×D×H)		mm	915×255×355			1010×285×380	
Net weight		kg	10			12	
Gross weight		kg	12.5			16	
Loading quantity	20'GP		365			290	
	40'GP		765			595	
	40'HQ		850			671	
Standard wireless remote controller		YB1FA(XFAN)					

Model			FP-34BA3/B-K	FP-51BA3/B-K	FP-68BA3/B-K	FP-85BA3/B-K
Code			EM55001720	EM55001730	EM55001750	EM55001740
Air flow volume	High	m ³ /h	360	510	680	830
		CFM	212	300	400	489
	Medium	m ³ /h	322	413	591	708
		CFM	189	243	348	417
	Low	m ³ /h	282	367	532	616
		CFM	166	216	313	363
Capacity	Cooling	W	1850	2650	3500	4550
	Heating	W	2450	3050	3850	4800
Power system	Type	V-Ph-Hz	220-240V~ 50Hz			
	Input	W	30	30	40	60
Water system	Water flow volume	m ³ /h	1.44	1.62	2.16	2.52
		GPM	6	7	10	11
	Pressure drop	kPa	13	25	40	65
		Ft·WG	4.26	7.87	14.43	14.76
Coil	Type		Aluminum fin-copper tube			
	Operating pressure	MPa	≤1.6MPa			
Motor	Type		FN6B	FN9A	FN13G	FN23A
	Capacitor	uF	1		1.5	
	Power output	W	6	9	13	22
Sound pressure level		dB(A)	35	40	43	48
Connection pipe size	Water inlet & outlet	inch	1/2"			
	Condensing water drain	mm	15.6			
Outline dimension (W×D×H)		mm	845×180×275		940×200×298	
Package dimension (W×D×H)		mm	915×255×355		1010×285×380	
Net weight		kg	8.8		10.8	
Gross weight		kg	11.8		14.8	
Loading quantity	20'GP		365		290	
	40'GP		765		595	
	40'HQ		850		671	
Standard wireless remote controller			YB1FA(X-FAN)			

Model			FP-51BWA2/A-K FP-51BWA3/A-K FP-51BWA5/A-K	FP-85BWA2/A-K FP-85BWA3/A-K FP-85BWA5/A-K	
Product Code			EM55000240 EM55001430 EM55000300	EM55000250 EM55001510 EM55000310	
Air flow volume		High	m ³ /h	450	650
			CFM	265	382
		Medium	m ³ /h	383	560
			CFM	225	329
		Low	m ³ /h	323	490
			CFM	190	288
Capacity	Cooling	W	1500	2400	
	Heating	W	2250	3600	
Power system	Type	V-Ph-Hz	220-240V~ 50Hz		
	Input	W	50	60	
Water system	Water flow volume	m ³ /h	0.28	0.38	
		GPM	1.23	1.67	
	Pressure drop	kPa	37	60	
		Ft-WG	12.2	19.7	
Coil	Type		Aluminum fin-copper tube		
	Operating pressure	MPa	≤1.6MPa	≤1.6MPa	
Motor	Type		FN20J-PG	FN20V-PG	
	Capacitor	uF	1	1.5	
	Power output	W	20	20	
Sound pressure level		dB(A)	42	50	
Connection pipe size	Water inlet & outlet	inch	1/2"		
	Condensing water drain	mm	15.6		
Outline dimension (W×D×H)		mm	845×180×275	940×200×298	
Package dimension (W×D×H)		mm	915×255×355	1010×285×380	
Net weight		kg	11	13	
Gross weight		kg	14	17	
Loading quantity		20'GP	365	290	
		40'GP	765	595	
		40'HQ	850	671	
Standard wireless remote controller			YB1FA		

Model		FP-34BA2/B-D FP-34BA3/B-D FP-34BA5/B-D	FP-51BA2/B-D FP-51BA3/B-D FP-51BA5/B-D	FP-68BA2/B-D FP-68BA3/B-D FP-68BA5/B-D	FP-85BA2/B-D FP-85BA3/B-D FP-85BA5/B-D	FP-102BA2/B-D FP-102BA3/B-D FP-102BA5/B-D		
Code		EM55000320 EM55001760 EM55001890	EM55000330 EM55001800 EM55001900	EM55000340 EM55001770 EM55001910	EM55000350 EM55001780 EM55001920	EM55000360 EM55001790 EM55001930		
Air flow volume		High	m ³ /h	360	550	680	850	1000
			CFM	212	324	400	500	588
		Medium	m ³ /h	322	413	591	708	840
			CFM	189	242	347	416	493
		Low	m ³ /h	282	367	532	616	720
			CFM	166	215	312	362	423
Capacity	Cooling	W	2100	2700	3600	4200	5400	
	Heating	W	3150	4050	5400	6300	8500	
Power system	Type	V-Ph-Hz	208-230V~ 60Hz					
	Input	W	50		60		70	
Water system	Water flow volume	m ³ /h	0.4	0.45	0.64	0.78	0.88	
		GPM	1.76	1.98	2.82	3.43	3.87	
	Pressure drop	kPa	13	24	44	45	63	
		Ft·WG	4.3	7.9	14.5	14.8	20.7	
Coil	Type		Aluminum fin-copper tube					
	Operating pressure	MPa	≤1.6MPa					
Motor	Type		FN20X-PG		FN20W-PG			
	Capacitor	uF	1		1.5			
	Power output	W	20					
Sound pressure level		dB(A)	35	40	43	48	49	
Connection pipe size	Water inlet & outlet	inch	1/2"					
	Condensing water drain	mm	15.6					
Outline dimension (W×D×H)		mm	845×180×275		940×200×298			
Package dimension (W×D×H)		mm	915×255×355		1010×285×380			
Net weight		kg	10		12			
Gross weight		kg	12.5		15			
Loading quantity		20'GP	365		290			
		40'GP	765		595			
		40'HQ	850		671			
Standard wireless remote controller		YB1FA(X-FAN)						

Model			FP-34BA2/D-K FP-34BA3/D-K FP-34BA4/D-K FP-34BA5/D-K	FP-51BA2/D-K FP-51BA3/D-K FP-51BA4/D-K FP-51BA5/D-K	FP-68BA2/D-K FP-68BA3/D-K FP-68BA4/D-K FP-68BA5/D-K	FP-85BA2/D-K FP-85BA3/D-K FP-85BA4/D-K FP-85BA5/D-K		
Product Code			EM55001810 EM55002000 EM55002040 EM55002080	EM55001820 EM55002010 EM55002050 EM55002090	EM55001830 EM55002020 EM55002060 EM55002100	EM55001840 EM55002030 EM55002070 EM55002110		
Air flow volume			High	m ³ /h	360	550	680	850
				CFM	212	324	400	500
			Medium	m ³ /h	322	413	591	708
				CFM	189	242	347	416
			Low	m ³ /h	282	367	532	616
				CFM	166	215	312	362
Capacity	Cooling	W	2000	2500	3600	4200		
	Heating	W	2700	3200	4600	5400		
Power system	Type	V-Ph-Hz	220-240V~ 50Hz					
	Input	W	50	50	60	66		
Water system	Water flow volume	m ³ /h	0.4	0.45	0.6	0.7		
		GPM	1.76	1.98	2.65	3.09		
	Pressure drop	kPa	20	36	53	70		
		Ft-WG	7	12	17	23		
Coil	Type	Aluminum fin-copper tube						
	Operating pressure	MPa	≤1.6MPa	≤1.6MPa	≤1.6MPa	≤1.6MPa		
Motor	Type	FN20J-PG			FN20V-PG			
	Capacitor	uF	1	1	1.5	1.5		
	Power output	W	20					
Sound pressure level		dB(A)	35	40	43	48		
Connection pipe size	Water inlet & outlet	inch	1/2"					
	Condensing water drain	mm	15.6					
Outline dimension (W×D×H)		mm	845×180×275			940×200×298		
Package dimension (W×D×H)		mm	915×255×355			1010×285×380		
Net weight		kg	10			12		
Gross weight		kg	12.5			16		
Loading quantity		20'GP	365			290		
		40'GP	765			595		
		40'HQ	850			671		
Standard wireless remote controller			YB1FA(XFAN)					

Model			FPD-34BB3/A-K	FPD-51BB3A-K	FPD-68BB3A-K	FPD-85BB3/A-K
Product Code			EM55002580	EM55002600	EM55002590	EM55002610
Air flow volume	High	m ³ /h	340	510	680	850
		CFM	200	300	400	500
	Medium	m ³ /h	255	382	510	637
		CFM	150	225	300	375
	Low	m ³ /h	170	255	340	425
		CFM	100	150	200	250
Capacity	Cooling	W	2.2	2.7	3.6	4.3
	Heating	W	2.4	2.9	3.9	4.7
Power system	Type	V-Ph-Hz	220~240-1Ph-50Hz			
	Input	W	12	18	29	43
Water system	Water flow volume	m ³ /h	0.40	0.50	0.64	0.77
		GPM	6.38	7.92	10.08	12.14
	Pressure drop	kPa	18.00	28.00	43.00	47.28
		Ft-WG	5.90	9.18	14.10	15.51
Coil	Type	Aluminum fin-copper tube				
	Operating pressure	MPa	≤1.6MPa			
Motor	Type	FN20V-ZL				FN60B-ZL
	Capacitor	uF	-	-	-	-
	Power output	W	0.01	0.02	0.03	0.04
Sound pressure level		dB(A)	31	36	43	48
Connection pipe size	Water inlet & outlet	inch	1/2"			
	Condensing water drain	mm	15.6			
Outline dimension (W×D×H)		mm	845×289×209	845×289×209	845×289×209	970×300×224
Package dimension (W×D×H)		mm	970×360×280	970×360×280	970×360×280	1090×305×380
Net weight		kg	10.5	10.5	10.5	12.5
Gross weight		kg	12.5	12.5	12.5	15.5
Loading quantity	20'GP		291	291	291	221
	40'GP		604	604	604	461
	40'HQ		682	682	682	525
Standard wireless remote controller			YAP1F	YAP1F	YAP1F	YAP1F

Note:

- (1) The water working temperature is from 7°C(44.6°F) to 60°C(140°F).
- (2) The temperature exchange efficiency and enthalpy exchange efficiency are tested under these testing conditions as below:
 - 1) Cooling efficiency: air 27°C (80.6°F) DB, 19°C (66.2°F) WB, water temperature in 7°C (44.6°F) water out 12°C(53.6°F).
 - 2) Heating efficiency: air 20°C (68°F) DB, water temperature in 50°C (122°F) , water out 40°C (104°F). water inlet temperature 45°C and water outlet temperature 40°C (Sales for EU countries)
 - (3) The operating water pressure of the models above is no more than 1.6MPa.

CONTROL

CONTROL

1 WIRELESS REMOTE CONTROLLER

Names and functions of wireless remote control

Note: Be sure that there are no obstructions between receiver and remote controller; Don't drop or throw the remote control; Don't let any liquid in the remote control and put the remote control directly under the sunlight or any place where it is very hot.



1.1 ON/OFF

ON/OFF button

Press **ON/OFF** button to turn on/off the unit. When the unit is turned off, the Timer, Sleep function will not be retained in memory, but the time will be retained and is still displaying.

1.2 MODE

MODE button

① Press this button, Auto, Cool, Dry, Fan Heat mode can be selected circularly.

② Under Cool mode, the initial value is 24°C(75°F) . Under Heat mode, the initial values 24°C(75°F).

Auto mode is not available in this mode.

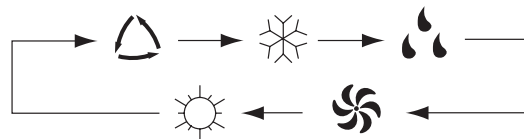

-  AUTO
-  COOL
-  DRY
-  FAN
-  HEAT

1.3 SLEEP

SLEEP button

Press this button to select Sleep On/Sleep Off. If power is on, Sleep Off is default. If the unit is turned off, the Sleep function setting will be not retained in memory. If Sleep function is on, the mark of Sleep will display. In this mode, the time of timer can be adjusted. Under Fan and Auto modes, this function is not available.

1.4 FAN

FAN button

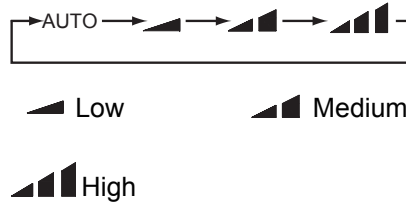

Press this button, Auto, Low, Medium, High-speed can be circularly selected. After powered on, Auto fan speed is default. Under Dehumidify mode, Low fan speed is default.



Note: Under the Dry mode, the fan speed isn't adjustable, low fan speed is default.



1.5 CLOCK

CLOCK button

Press Clock button to set the time of clock. When  blinks and displays, you can set the time by pressing + or - button. If no button is pressed within 10 seconds the remote will revert back to the normal display. Press  again to accept the setting. If it is set the first time, 12:00 is the initial value. Note: If mark  displays on the LCD, it means it is the time of clock, if not, it is the time of timer.

1.6 LIGHT

LIGHT button

Press this button to select LIGHT On/Off in the displayer. When the LIGHT On is set, the mark  will be displayed and the indicator light in the displayer will be on. When the LIGHT Off is set, the mark  will disappear and the indicator light will be off.

2 OPERATION OF WIRELESS REMOTE CONTROL

Note: This is a general remote control, it could be used for multiple types (functions) of air conditioners. For some models without the functions specified here, we preserve the right to not to inform exclusively.

2.1 X-FAN

X-FAN button

- ① Press this button to turn on/off the X-FAN function.
- ② The function is not available for this function.

2.2 - button

Presetting temperature can be decrease the temperature by 1 degree Celsius once. press and hold for more than two seconds so that we can change the temperature continuously. The minimum and maximum setting range of the temperature is 16 to 30 degree Celsius.

2.3 + button

Press this button increase the temperature by 1 degree Celsius once. Press and hold for more than two seconds so that we can change the temperature continuously. The minimum and maximum setting range of the temperature is 16 to 30 degree.

2.4 TEMP.

TEMP. button

Press this button to select the display of either indoor setting temperature or indoor ambient temperature. When the indoor unit powered on firstly, setting temperature display is default. Change status to  to display the ambient temperature. If received control signal in 5 seconds, the display temp. will revert back to setting temperature. When unit is off, indoor setting temperature display is default. Note: This function is only available for certain models.

2.5 TURBO

TURBO button

In Cool or Heat mode, press this button to turn on/off the Turbo function.
Note: This function is not available for this model.

3 OPERATION OF WIRELESS REMOTE CONTROL

Note: This is a general remote control, it could be used for multiple types (functions) of air conditioners. For some models without the functions specified here,



we preserve the right to not to inform exclusively.

3.1 SWING UP AND DOWN BUTTON

Press this button to adjust swing angle, which circularly changes as below:

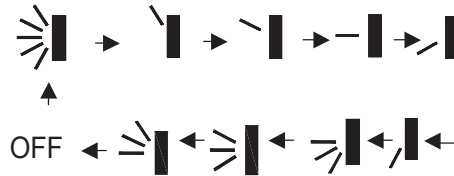

This is a general use remote control. If remote control shows the following three kinds of status that the swing status of main unit will be:



When the guide louver start to swing up and down, if turn off the Swing, the air guide louver will stop at current position.

➤ which indicates the guide louver swings up and down between the five positions.

3.2 TIMER ON BUTTON

Press the TIMER ON button to set the timed On. Press +/- once to increase or decrease the minute by 1 minute. If pressed and held for 2 seconds, the minute will increase or decrease constantly by 1 minute. If held constantly for more than 5 seconds, the minute will begin to change in every 10 minutes. Press TIMER ON again to accept the setting and ON will show besides the time of clock meaning the setting succeeds. Press the TIMER ON again to cancel the setting.

3.3 TIMER OFF BUTTON

Press the TIMER OFF button to set the timed Off. The procedures are similar as above.

4 OPERATION OF WIRELESS REMOTE CONTROL

4.1 Guide for operation – General operation

- ① Press **SLEEP** button to set the sleep state.
- ② Press **TIME ON** and **TIME OFF** button to scheduled the unit **ON/OFF**
- ③ Press **LIGHT** button to control on and off the indicator board.(This function maybe not available for some units).

4.2 Guide for operation-Optional operation

- ① After powered on, press **ON/OFF** button, the unit will start to run. (**Note:** When it is powered off , the guide louver of main unit will close automatically.)
- ② Press **MODE** button, select desired running mode, or press **COOL** or **HEAT** mode to enter the corresponding operation directly.
- ③ Press + or - button to set the desired temperature.
- ④ Press **FAN** button to set fan speed from **AUTO, FAN ,LOW MID** and **HIGH**.
- ⑤ Press ➤ button to select **SWING** mode.

4.3 Operation of wireless remote control

- ① Press + and - buttons simultaneously to lock or unlock the wireless remote control. If it is locked, the mark will display; when pressing any button, the mark will blink for three times but the air conditioner has no despondence. If unlocked, the mark will disappear.
- ② Switch between Fahrenheit and Centigrade. When unit is under Off state, press **MODE** and - button simultaneously to switch between °C and °F.

5 CHANGING BATTERIES AND NOTICES

- ① Slightly to press the place with  , along the arrowhead direction to push the back cover of wireless remote control. (As show in figure)
- ② Take out the old batteries. (As show in figure)
- ③ Insert two new AAA1.5V dry batteries, and pay attention to the polarity (as show in figure).



④ Attach the back cover of wireless remote control (as show in figure).



NOTE:

- When changing the batteries, do not use the old or different batteries, otherwise, it can cause the malfunction of the wireless remote control.
- If the wireless remote control will not be used for a long time, please take them out, and don't let the leakage liquid damage the wireless remote control.
- The operation should be in its receiving range.
- It should be placed at where is 1m away from the TV set or stereo sound sets.
- If the wireless remote control can not operate normally, please take them out, after 30s later and reinsert, if they cannot normally run, please change them.
- leakage liquid damage the wireless remote control.

6 REMOTE CONTROLLER YAP1F

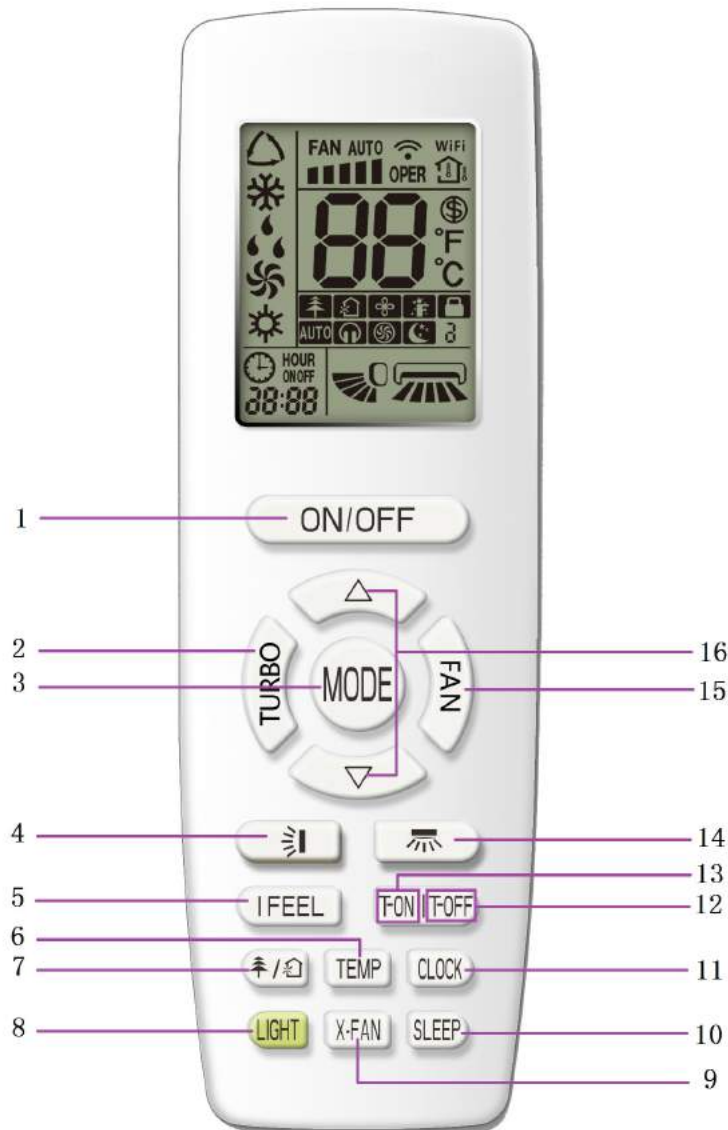
6.1 Button name and function introduction



No.	Button name	Function
1	ON/OFF	Turn on or turn off the unit
2	TURBO	Set turbo function
3	MODE	Set operation mode
4		Set up&down swing status
5	I FEEL	Set I FEEL function
6	TEMP	Switch temperature displaying type on the unit's display
7		Set health function and air function
8	LIGHT	Set light function
9	X-FAN	Set X-FAN function
10	SLEEP	Set sleep function
11	CLOCK	Set clock of the system
12	TOFF	Set timer off function
13	TON	Set timer on function
14		Set left&right swing status
15	FAN	Set fan speed
16	Δ / ∇	Set temperature and time

6.2 Preparation before operation

When using the remote controller for the first time or after replacing the batteries, please set the time of the system according to current time in the following steps:

- (1) Pressing CLOCK button,  is blinking.
- (2) Pressing Δ or ∇ button, the clock time will increase or decrease rapidly.
- (3) Press CLOCK button again to confirm the time and return to display current time.

6.3 Introduction of operation function

- (1) Selecting operation mode

In unit on status, press MODE button to select operation mode in following sequence:



- (2) Setting temperature

In unit on status, press Δ button to increase setting temperature and press ∇ button to decrease setting temperature. The range of temperature is from 16 °C to 30 °C .

Note: Under auto mode, manual adjustment of temperature is not needed.

- (3) Adjusting fan speed

In unit on status, press FAN button to adjust fan speed in following sequence:

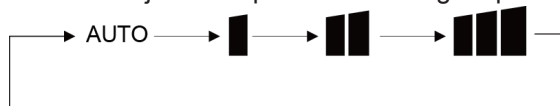



Notes:

- ① When operation mode changes, fan speed is memoried;
- ② Under dry mode, fan speed is low and can not be adjusted.

- (4) Setting swing function

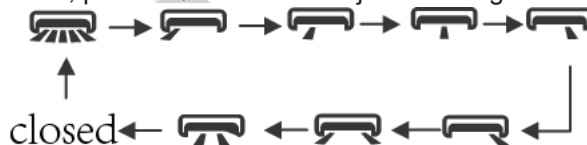

- 1) Setting left & right swing

- Under simple swing status, press  button to adjust left & right swing status;
- Under fixed-angle swing status, press  button to adjust left & right swing angle circularly as below:



Note: operate continuously left&right swing in 2 seconds, swing states will change according to above-mentioned order, or switch closed state and  state.

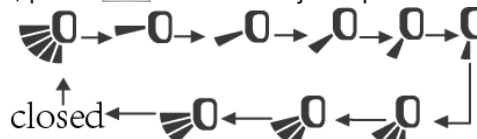

2) Setting up&down swing

- Under simple swing status, press  button to adjust up&down swing status;
- Under fixed-angle swing status, press  button to adjust up&down swing angle circularly as below:



Note: operate continuously left&right swing in 2 seconds, swing states will change according to above-mentioned order, or switch closed state and  state;

(5) Setting turbo function

- 1) Under cool or heat mode, press TURBO button to set turbo function.
- 2) When  is displayed, turbo function is on.
- 3) When  is not displayed, turbo function is off.
- 4) When turbo function is on, the unit operates in super high speed to achieve quick cooling or heating.



When turbo function is off, the unit operates in setting fan speed.

(6) Setting light function

The light on the receiver light board will display present operation status. If you want to turn off the light, please press LIGHT button. Press this button again to turn on the light.



(7) Viewing ambient temperature

1) In unit on status, receiver light board or wired controller is defaulted to display setting temperature. Press TEMP button to view indoor or outdoor ambient temperature.

- 2) When  is displayed, it means the displayed temperature is setting temperature.
 - 3) When  is displayed, it means the displayed temperature is indoor ambient temperature.
- When  is displayed, it means the displayed temperature is outdoor ambient temperature.



Note: setting temperature is always displayed in Remote Controller.

(8) Setting X-FAN function





- 1) In cool or dry mode, press X-FAN button to set X-FAN function.
- 2) When  is displayed, X-FAN function is on.
- 3) When  is not displayed, X-FAN function is off.
- 4) When X-FAN function is on, the water on the evaporator will be blown away until turning off the unit to avoid mildew.

Note: setting temperature is always displayed in Remote Controller.



(9) Setting health function

- 1) In unit on status, press  button to set health function.
- 2) When  is displayed, health function is on.
- 3) When  is not displayed, health function is off.
- 4) Health function is available when the unit is equipped with anion generator. When health function is on, the anion generator will start operation, adsorbing the dusts and killing the bacteria in the room.

(10) Setting air function

- 1) Press  button until  is displayed, then air function is turned on.
- 2) Press  button until  is disappeared, then air function is turned off.
- 3) When the indoor unit is connected with fresh air valve, air function setting can control the connection of fresh air valve, which can control the fresh air volume and improve the air quality inside the room.



(11) Setting sleep function

- 1) In unit on status, press SLEEP button to turn on or turn off sleep function.
- 2) When  is displayed, sleep function is on.
- 3) When  is not displayed, sleep function is off.

Notes:

- Sleep function can not be set in auto and fan mode;
- When turning off the unit or switching mode, sleep function is cancelled;

(12) Setting I FEEL function

- 1) In unit on status, press I FEEL button to turn on or turn off I FEEL function.
- 2) When  is displayed, I FEEL function is on.
- 3) When  is not displayed, I FEEL function is off.
- 4) When I FEEL function is turned on, the unit will adjust temperature according to the temperature detected by the remote controller to achieve the best air-conditioning effect. In this case, you should place the remote controller within the valid receiving range.

(13) Setting timer

You can set the operation time of unit as you need. You can also set timer on and timer off in combination.

Before setting, check if the time of the system is the same as the current time. If not, please set the time according to current time.

1) Setting timer off

a Pressing TOFF button, "OFF" is blinking and time displaying zone displays the timer time of last setting.

b Press Δ or ∇ button to adjust the timer time.

c Press TOFF button again to confirm setting. OFF is displayed and time displaying zone resumes to display current time.

d Press TOFF button again to cancel timer and OFF is not displayed.

2) Setting timer on

a Pressing TON button, "ON" is blinking and time displaying zone displays the timer time of last setting.

b Press Δ or ∇ button to adjust the timer time.

c Press TON button again to confirm setting. ON is displayed and time displaying zone resumes to display current time.

d Press TON button again to cancel timer and ON is not displayed.

6.4 Introduction of special functions

(1) Setting child lock

a Press Δ and ∇ button simultaneously to lock the buttons on remote controller and \blacksquare is displayed.

b Press Δ and ∇ button simultaneously again to unlock the buttons on remote controller and \blacksquare is not displayed.

c If the buttons are locked, \blacksquare blinks 3 times when pressing the button and any operation on the button is invalid.

(2) Switching temperature scale

In unit off status, press MODE button and ∇ button simultaneously to switch temperature scale between $^{\circ}\text{C}$ and $^{\circ}\text{F}$.

(3) Setting energy-saving function

1) In unit on status and under cool mode, press CLOCK and TEMP button simultaneously to enter energy-saving mode.

• When SE is displayed, energy-saving function is on.

• When SE is not displayed, energy-saving function is off.

2) If you want to turn off the energy-saving function, press CLOCK and TEMP button and SE is not displayed.

Note: energy-saving function is only available in cooling mode and it will be exited when switching mode or setting sleep function.

(4) Absence function

1) In unit on status and under heat mode, press CLOCK and TEMP button simultaneously to enter absence function. Temperature displaying zone displays 8 and S is displayed.

2) Press CLOCK and TEMP button simultaneously again to exit absence function. Temperature displaying zone resumes previous display and S is not displayed.

3) In winter, absence function can keep the indoor ambient temperature above 0°C to avoid freezing.

Note: Absence function is only available in heating mode and it will be exited when switching mode or setting sleep function.

6.5 Replacing batteries in remote controller and notes

(1) Lift the cover along the direction of arrow (as shown in Fig 1 ①).

(2) Take out the original batteries (as shown in Fig 1 ②).

(3) Place two 7# (AAA 1.5V) dry batteries, and make sure the position of "+" polar and "-" polar is correct (as shown in Fig 2 ③).

(4) Reinstall the cover (as shown in Fig 2 ④).

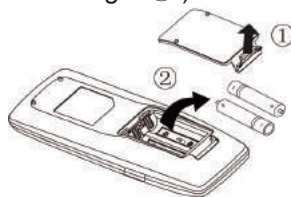

Fig. 1

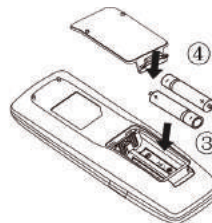



Fig. 2

Notes:

- The remote controller should be placed 1m away from the TV set or stereo sound sets.
- The operation of remote controller should be performed within its receiving range.
- If you need to control the main unit, please point the remote controller at the signal receiving window of the main unit to improve the receiving sensibility of main unit.
- When the remote controller is sending signal, “” icon will be blinking for 1 second. When the main unit receives valid remote control signal, it will give out a sound.
- If the remote controller does not operate normally, please take the batteries out and reinsert them after 30 seconds. If it still can't operate properly, replace the batteries.
- When replacing the batteries, do not use old or different types of batteries, otherwise, it may cause malfunction.
- When you won't use the remote controller for a long time, please take out the batteries.

7 WIRED CONTROLLER OPERATION

The controller is optional for the existing models of wall mounted type fan coil units but cannot match the model FPD-XX.

7.1 LCD Display

7.1.1 Symbols on the LCD

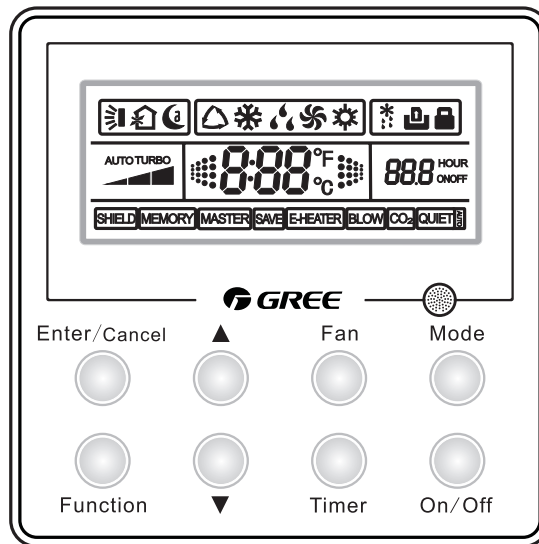

Fig.1 Appearance of the Wired Controller

7.1.2 Introduction to the Symbols on the LCD

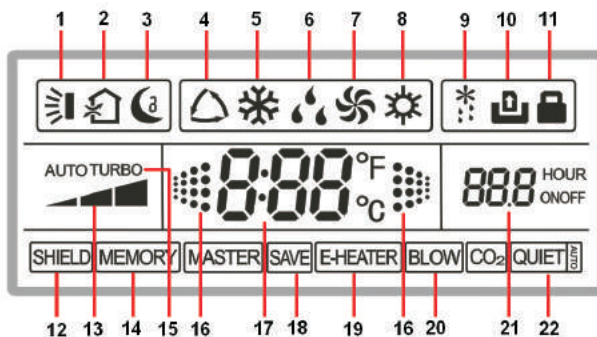
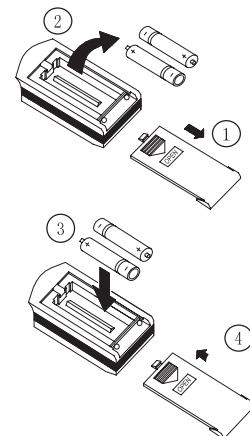

Fig.2 Symbols on the LCD



Sketch map for
changing batteries

Table 1 Introduction to the Symbols on the LCD

No.	Symbol	Function Description
1		It indicates the swing function.
2		It indicates the function of air exchange. (It is unavailable for this wired controller.)
3		It indicates the sleeping status.
4		It indicates each running mode of the indoor unit (AUTO mode). (It is unavailable for this wired controller.)
5		It indicates the "Cool" mode.
6		It indicates the "Dry" mode.
7		It indicates the "Fan" mode.
8		It indicates the "Heat" mode.
9		It indicates the defrosting mode. (It is unavailable for this wired controller.)
10		It indicates the gate control status.
11		It indicates the locking status.
12		It indicates the shield status. (It appears when all functions, or the function "On/Off", "Temp", "Mode", or "Save" is shielded through the Long-distance monitoring System.)
13		It indicates the current fan speed.
14		It indicates the memory function is activated, that is, the unit will back to the previous set status after powered on again.
15		It indicates the turbo status.
16		It flashes animatedly when the unit is started and the ambient temperature is displayed.
17		It indicates the ambient temperature/set temperature.
18		It indicates the energy saving status.
19		It indicates that the auxiliary electric heater can be activated.
20		It indicates the blow function is activated.
21		It indicates the timer status.
22		It indicates the quiet operation status. (including two statuses, "Quiet" and "Auto Quiet".)

Note: Symbols "MASTER" and "CO2" will not displayed on the LCD of the wired controlled XK26.

7.2 Press Keys

7.2.1 Name of Press Keys

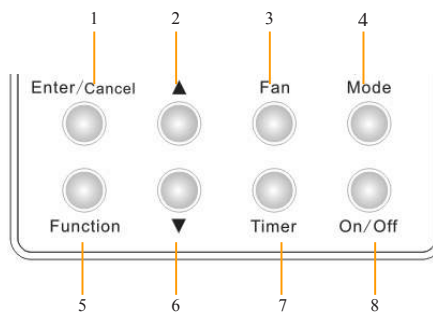

7.2.2 Introduction to the Functions of the Press Keys

Table 2 Introduction to the Functions of the Press Keys

No.	Press Bottoms	Function Description
1	Enter/Cancel	It is used to select the desired function or cancel the selected function.
2	▲	(1) It is used to adjust the running temperature of the indoor unit among 16~30℃ . (2) It is used to adjust the temperature under the energy saving condition among 16~30℃ . (3) It is used to adjust the timer among 0.5~24 hours.
6	▼	(4) It is used to switch between the modes of "Quiet" and "Auto Quiet" .
3	Fan	There are four fan speed options, High, Medium, Low and Auto.
4	Mode	(1) It is used to set the mode of "Cool", "Dry", "Fan", and "Heat". (2) When the "Save" function is being set, it is used to switch between the mode options of "Heat" and "Cool". (3) When the "Timer" is being set, it is used to switch between the options of "Unit On" and "Unit Off".
5	Function	It is used to switch the functions of "Swing", "Sleep", "Turbo", "Save", "E-Heater", "Blow", "Quiet", etc.
7	Timer	It is used to set the timer.
8	On/Off	It is used to start/stop the indoor unit.
4 + 2	Mode + ▲ (MEMORY)	Under the "Off" status of the unit, press "Mode" and "▲" simultaneously for five seconds to activate or deactivate the "MEMORY" function. (once this function is activated, the unit with power failure will resume the previous set status after powered on again; otherwise it will go to the "Off" status.)
2 + 6	▲ + ▼ (LOCK)	Press "▲" and "▼" simultaneously for five seconds to go to the lock status, in which case the press on any other key will get no response. And another press on "▲" and "▼" for five seconds will quit this status.
5 + 7	Function + Timer (Ambient Temperature Sensor; Anti Cold/Hot Air)	Under the "Off" status of the unit, press "Function" and "Timer" simultaneously for five seconds to call out the debugging menu, after that press "Mode" to select the desired submenu and press "▲"/"▼" to set the parameter, finally press "Enter/Cancel" to save the setting and quit the setting status.
4 + 6	Mode + ▼	Under the "Off" status of the unit, press "Mode" and "▼" simultaneously for five seconds to switch the Celsius scale and Fahrenheit scale.

7.3 Installation Instructions

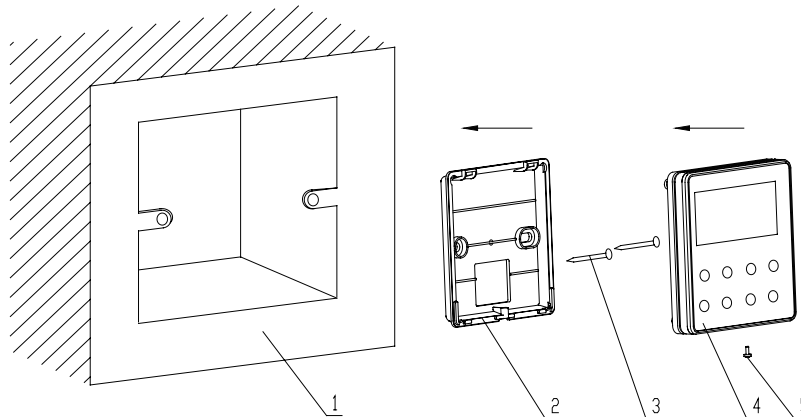

Fig.4 Installation of the Wired Controller

No.	1	2	3	4	5
Name	Installation Box	Base Plate	Screw M4X25	Front Panel	Screw ST2.2X6.5

Fig.4 presents simply how to install the wired controller and please pay special attention to the following instructions.

(1) Please cut off the power supply for all buried power cords in the installation hole and the whole installation must be done without any live part.

(2) Pull out the four-core twisted pairs in the installation hole and let it go through the rectangular hole on the base plate of the wired controller.

(3) Fix the base plate on the wall with screws M4X25.

(4) Let the four-core twisted pairs go through the slot of the wired control and then fix the front panel and base plate together.

(5) Fasten the front panel and base plate with screws ST2.2X6.5.

NOTE

Pay special attention to the electric wiring to prevent that the air conditioner goes out of control owing to the electromagnetic interference.

① The signal line and communication line should be separated with the power cord and the connecting wires between indoor and outdoor units should be with a minimal distance of 20cm, otherwise the communication would go wrong.

② If the air conditioner is installed where it would be affected by electromagnetic interference, the signal line and the communication line must be the shielded twisted pairs.

7.4 Operation Instructions

7.4.1 On/Off

- Under the “Off” status of the unit, press “On/Off” to start the unit.
- Under the “On” status of the unit, press “On/Off” to stop the unit.
- Fig. 5 is the “Off” status when the unit is powered on. Fig.6 show the “On” status when the unit is powered on.

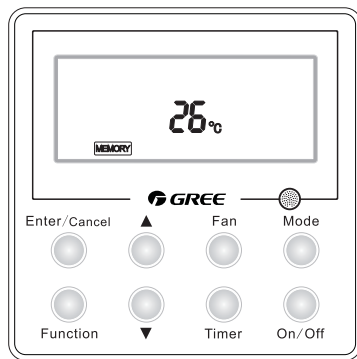

Fig.5 “Off” Status

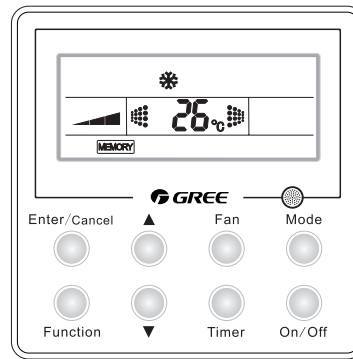
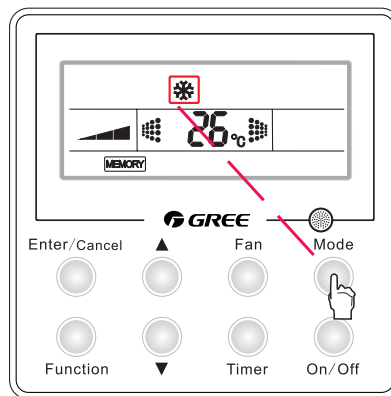
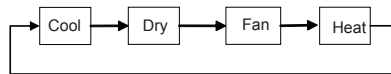

Fig.6 “On” Status

7.4.2 Mode

Under the “On” status, each press on “Mode” can change the modes circularly as the following order.



7.4.3 Temperature Setting

Under the “On” status, press “▲” and “▼” to increase or decrease the set temperature. A long-time press will make the temperature go up or down by 1°C/°F per 0.3 seconds.
Temperature Range:16°C ~ 30°C .

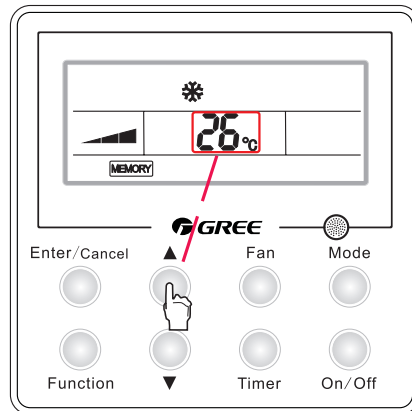

Fig. 8 Temperature Setting

7.4.4 Swing

How to activate the “Swing” function: under the “On” status of the unit, press the “Function” key to go to the setting status with the symbol “≡■” flashing, and then press “Enter/Cancel” to make a confirmation and the symbol “≡■” will stop flashing.

How to deactivate the “Swing” function: under the “On” status of the unit, press the “Function” key to go to the setting status with the symbol “≡■” flashing, and then press “Enter/Cancel” to deactivate this function and the symbol will disappear.

See Fig. 10 for how to activate the “Swing” function.

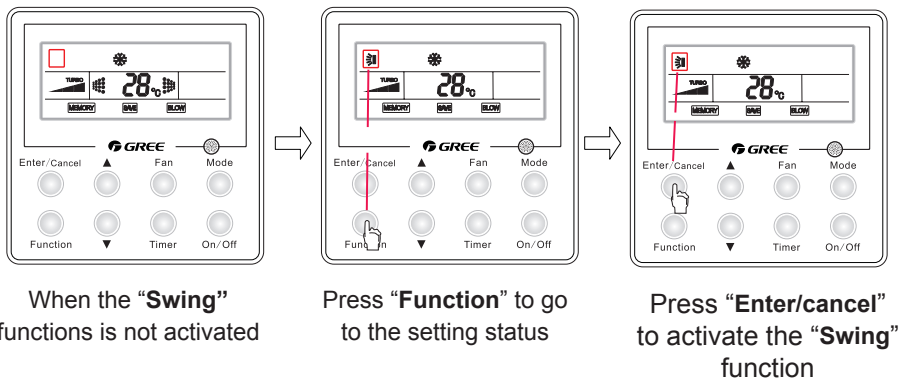

See Fig.11 for how to deactivate the “Swing” function.

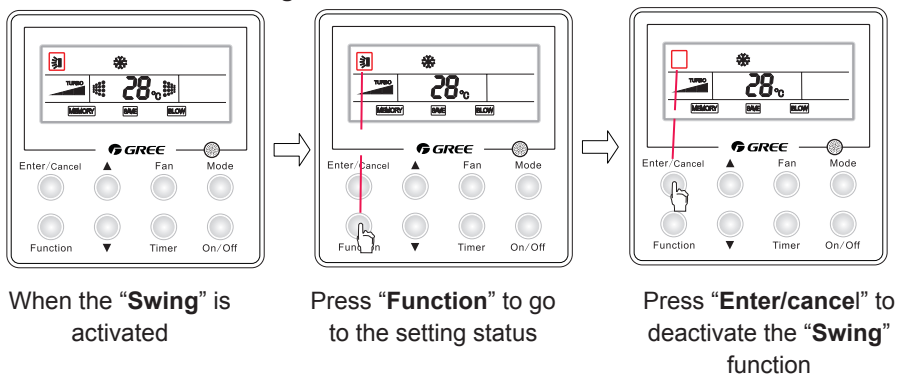

▲ NOTE: If the setting of the swing function is “Off”, the swing angle may change after the unit is powered on again.

7.4.5 Timer

Under the “ On” or “Off” status, press the “Timer” key to set the time when to automatically start or stop the unit.

How to set timer for unit "On": Under the "Off" state of the unit, press the "Timer" key with the symbol "ON" in the timer zone flashing, and then press "▲" or "▼" to set when to start the unit, after that, press the "Timer" key again to finish this setting. Before pressing "Timer" key to finish the setting for unit "On", it is also available to go to set when to stop the unit by pressing the "Mode" key with the symbol "OFF" flashing, and then press "▲" or "▼" to adjust the time, after that, press the "Timer" to finish this setting. Finally, the time displayed is for the unit "On" while time for unit "Off" will not be displayed.

How to set timer for unit "Off": When the unit is "On", press the "Timer" key with the symbol "OFF" flashing, and then press "▲" or "▼" to set the time when to stop the unit, after that, press the "Timer" key again to finish this setting. Before pressing the "Timer" key to finish the setting for unit "Off", it is also available to go to set when to start the unit by pressing the "Mode" key with the symbol "ON" flashing, and then press "▲" or "▼" to adjust the timer, after that, press the "Timer" key again to finish the setting. Finally, the time displayed is for the unit "Off" while time for unit "On" will not be displayed.

How to cancel the timer: When the timer is set, press "Timer" to cancel it and then no time will be displayed on the LCD.

See Fig.12 for how to set the timer under the "On" status of the unit.

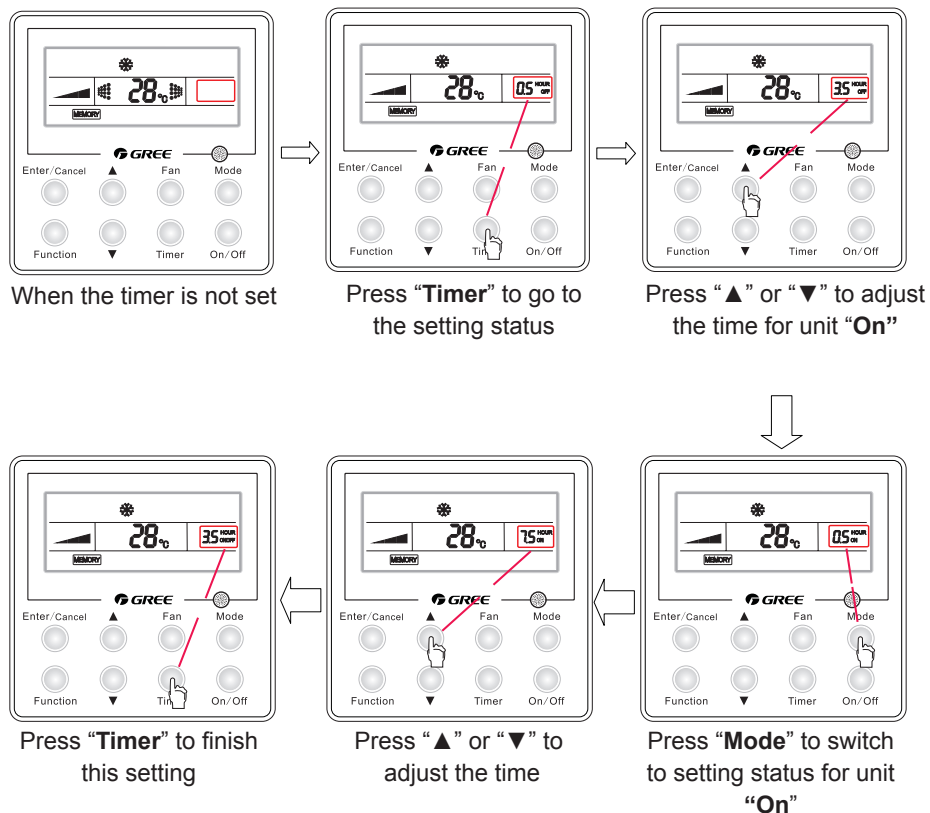

Fig.12 How to Set the "Timer"

See Fig.13 for how to cancel the timer under the "On" status of the unit.

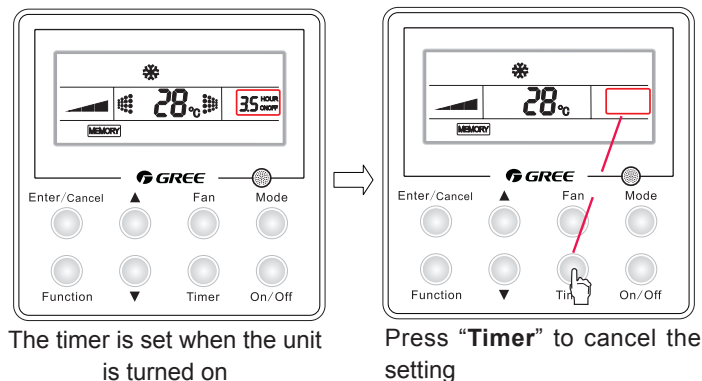

Fig. 13 How to Cancel the "Timer"

Timer Range: 0.5 ~ 24 hours, Each press on "▲" or "▼" will increase or decrease the timer by 0.5 hour. And the long-time press will increase or decrease the timer by 0.5 hour per 0.3 second.

▲ NOTE

① When the unit is “On”, if the time for unit “On” and unit “Off” have been set, then only the time for unit “Off” will be displayed on the wired controller. When the unit is “Off”, if the time for unit “On” and unit “Off” have been set, then only the timer for unit “On” will be displayed on the wired controller.



② When the unit is “Off”, the time for unit “On” starts as soon as the time for unit “Off” ends. When the unit is “On”, the time for unit “Off” starts as soon as the time for unit “On” ends.



7.4.6 Sleep

(1) Sleep Function

4) Under the “Cool” and “Dry” Mode, when the unit has run for one hour, the set temperature will go up by 1°C, and then another 1°C in another hour, then the temperature will not change any more.

5) Under the “Heat” mode, when the unit has run for one hour, the set temperature will go down by 1°C, and then another 1°C in another hour, and then the temperature will not change any more.

(2) How to activate the “Sleep” function: When the unit is “On” and the “Sleep” function is deactivated, press the “Function” key to go to the setting state of the “Sleep” function with the symbol “” flashing, after that, press the “Enter/Cancel” key to make a confirmation and then the symbol “” will stop flashing.

(3) How to deactivate the “Sleep” function: When the unit is “On” and the “Sleep” function is activated, press “Function” to go to the setting state of the sleep function with the symbol “” flashing, after that, and then press “Enter/Cancel” to make a confirmation and the symbol “” will disappear.

See Fig.14 for how to activate the “Sleep” function.

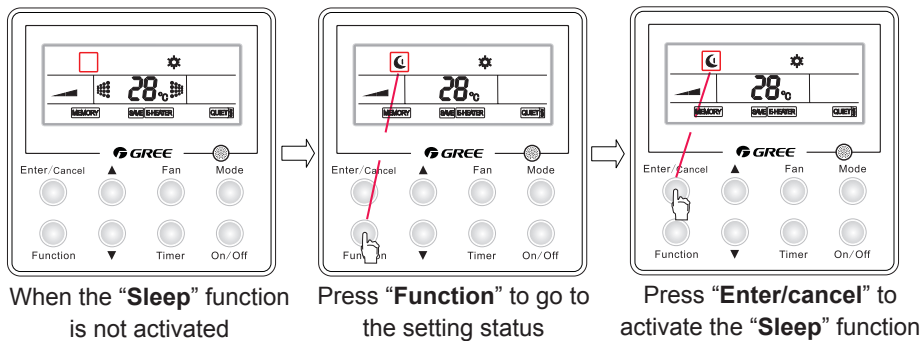

Fig.14 How to Activate the “Sleep” Function

See Fig.15 for how to deactivate the “Sleep” function.

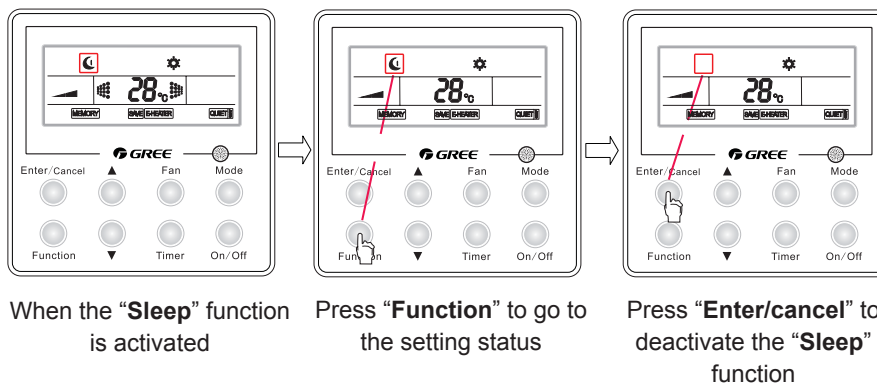

Fig.15 How to Deactivate the “Sleep” Function

▲ NOTE

① The default setting for the “Sleep” function is “Off” when the unit is powered on again after power failure.

② This function is unavailable under the “Fan” mode.

7.4.7 Turbo

“Turbo” function: It is a function to make the temperature of the conditioned air approach the set value rapidly through high-speed running of the fan under either “Cool” or “Heat” mode.

How to active the “Turbo” function: under the “Cool” or “Heat” mode, when the “Turbo” function is “Off”, press the “Function” key to go to the setting status of the “Turbo” function with the symbol “” flashing, after that, press the “Enter/Cancel” key to make a confirmation and then the symbol stops flashing.

How to deactivate the “Turbo” function: When the unit “On” and the “Turbo” function is activated, press the “Function” key to go to the setting state of the “Turbo” function with the symbol “” flashing, after that, press

the “Enter/Cancel” key to make a confirmation and then the symbol “TURBO” disappear .

See Fig.16 for how to activate the “Turbo” function.

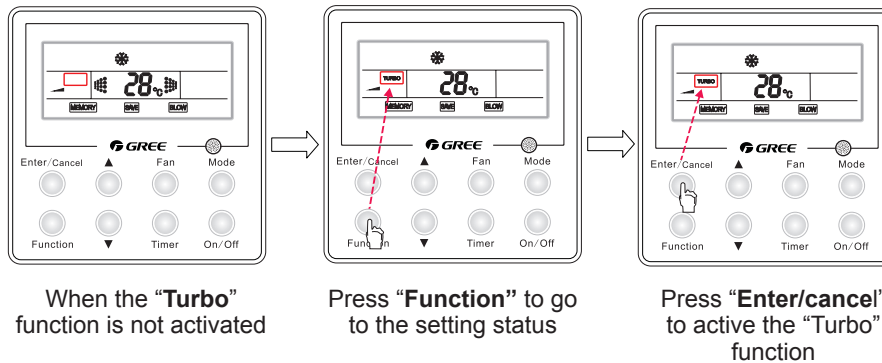

See Fig.17 for how to deactivate the “Turbo” function.

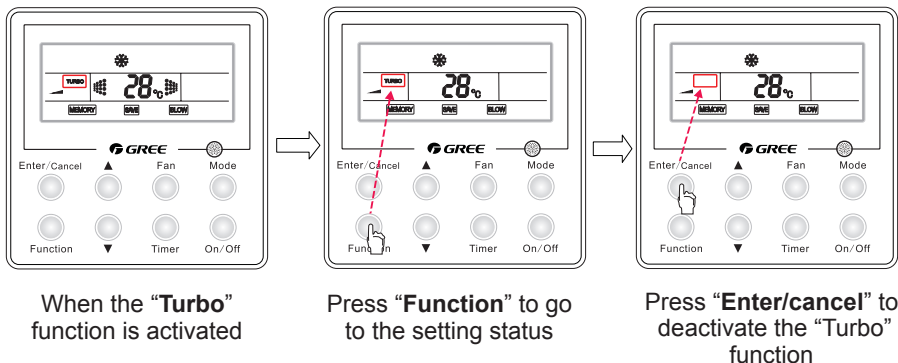

Fig.17 How to Deactivate the “Turbo” Function

▲ NOTE:

- ① The “Turbo” function is deactivated when the unit is powered on after power failure.
- ② Under the “Dry” and “Fan” modes, the “Turbo” function is unavailable and the symbol “TURBO” will not appear.
- ③ The “Turbo” function will be deactivated automatically when the “Quiet” function is activated.
- ④ The “Turbo” function will be deactivated automatically when the “Fan” speed is adjusted.

7.4.8 Save

(1) “Save” Function

6) This function is intended to save energy through limiting the temperature range under “Cool”, “Dry” or “Heat” mode.

7) The set temperature range for energy saving under the “Cool” or “Dry” mode is from the set point to 30°C .

8) The set temperature range for energy saving under the “Heat” mode is from 16°C to the set point.

(2) How to set the “Save” function under the “Cool” mode.

9) When the unit is “On”, press “Function” to go to the setting state of the “Save” function with the symbol “” flashing.

10) Press the “▲” or “▼” key to adjust the set temperature.

11) Press the “Enter/Cancel” key to activate the “Save” function.

(3) How to set the “Save” function under the “Heat” mode.

12) When the unit is “On”, press “Function” to go the setting state of the “Save” function with the symbol “” flashing.

13) Press “Mode” to switch to the setting status for heating.

14) Press “▲” or “▼” to adjust the set temperature.

15) Press “Enter/Cancel” to activate the save function.

(4) How to deactivate the “Save” function: When the “Save” function is activated, press the “Function” key to go to the setting state of this function with the symbol “” flashing, after that, press the “Enter/Cancel” key to cancel the “Save” function and the symbol will disappear.

See Fig.18 for how to activate the “Save” function.

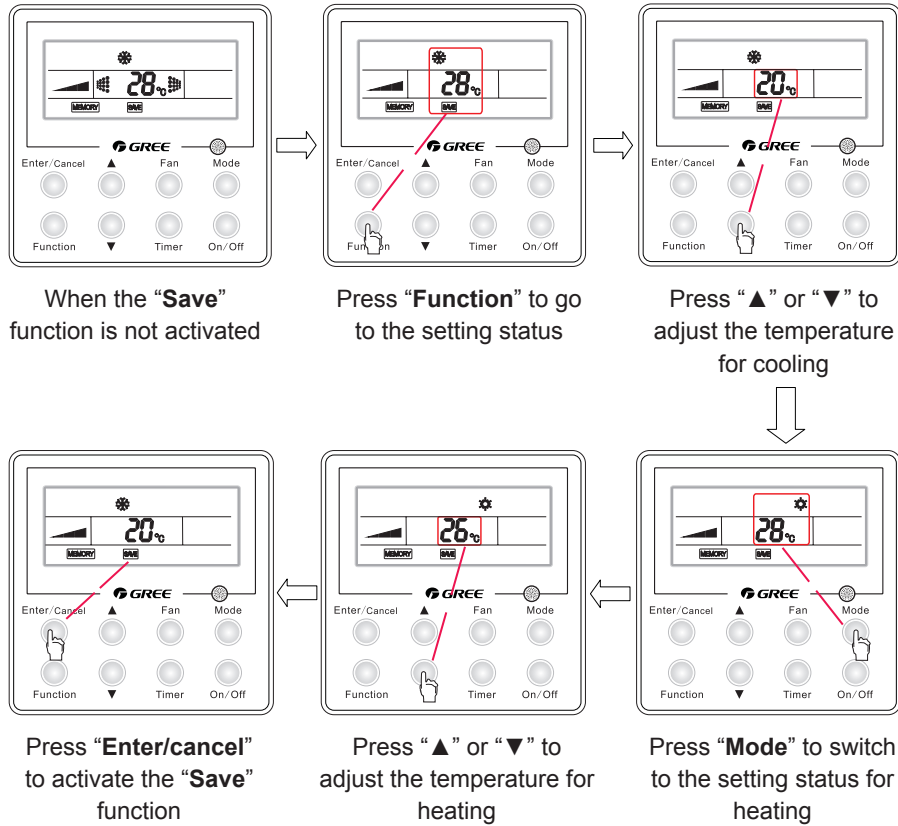

Fig. 18 How to Activate the “Saving” Function

See Fig. 19 how to deactivate the “Save” function.

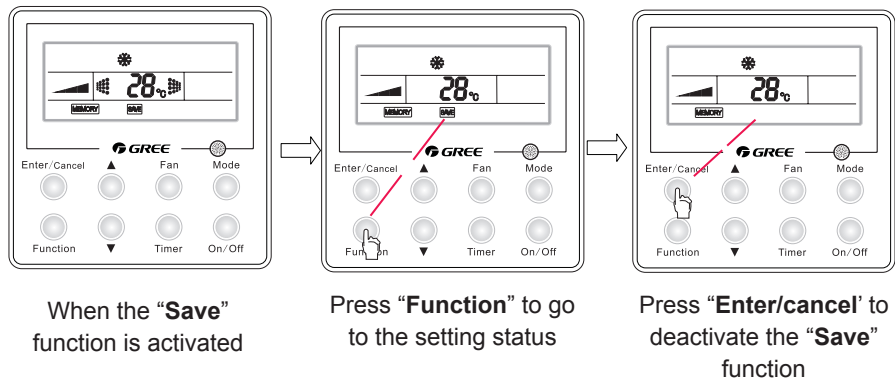

Fig.19 How to Deactivate the “Save” Function

▲ NOTE

- ① The “Sleep” function will be deactivated when the “Save” function is activated.
- ② The “Save” function will be memorized when the unit is powered on again after power failure.
- ③ The initial lower temperature limit under the “Save” cooling mode is 16°C and the initial upper temperature limit is “30°C” under the “Save” heating mode.
- ④ When the “Save” function is activated, if the set temperature under each mode is higher than the corresponding temperature limit for energy saving, then the set temperature will forcibly go to the temperature limit.

7.4.9 E-Heater

“E-heater” Function: Under the “Heat” mode, the heating efficiency can be improved greatly by activating the auxiliary electric heater.

How to active the “E-heater” function: Under the “Heat” mode, press the “Function” key to go to the setting state with the symbol “EHEATER” flashing, after that, press “Enter/Cancel” to make a confirmation and then the symbol will stop flashing.

How to deactivate the “E-heater” function: When the “E-heater” function is activated, press the “Function”

key to go to the setting state of the “E-heater” function with the symbol “**E-HEATER**” flashing, after that, press the “Enter/Cancel” key to deactivate this function and then the symbol “**E-HEATER**” will disappear.
See Fig. 20 for how to activate the “E-heater” function.

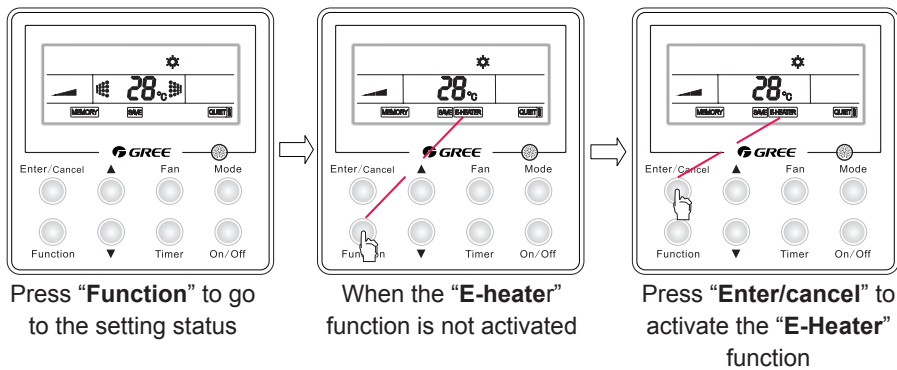

Fig. 20 How to Activate the “E-heater” function

See Fig.21 for how to deactivate the “E-heater” function.

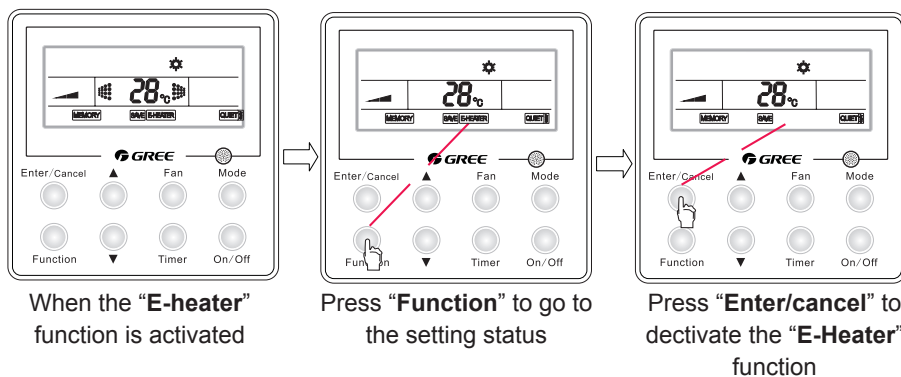

Fig.21 How to Deactivate the “E-heater” Function

NOTE:

① The “E-heater” function is unavailable under the “Cool”, “Dry” or “Fan” mode and the symbol “**E-HEATER**” will not be displayed on the LCD under those modes.

② When the unit is switched to the “Heat” mode, the default status of the “E-heater” function is “On”.

7.4.10 Blow

“Blow” Function:It is intended to dry the moisture inside the evaporator after the unit is turned on to prevent mould growing there.

How to activate the “Blow” function:Under the “Cool” and “Dry” mode, when the “Blow” function is not activated, press the “Function” key to go to the setting state with the symbol “**BLOW**”flashing, and then press the key “Enter/Cancel” to make a confirmation.

How to deactivate the “Blow” function:When the unit is “On” and the “Blow” function is activated, press “Function” function to go to the setting state with the symbol “**BLOW**”flashing, and then press the “Enter/Cancel” key to deactivate this function.

See Fig. 22 for how to activate the “Blow” function.

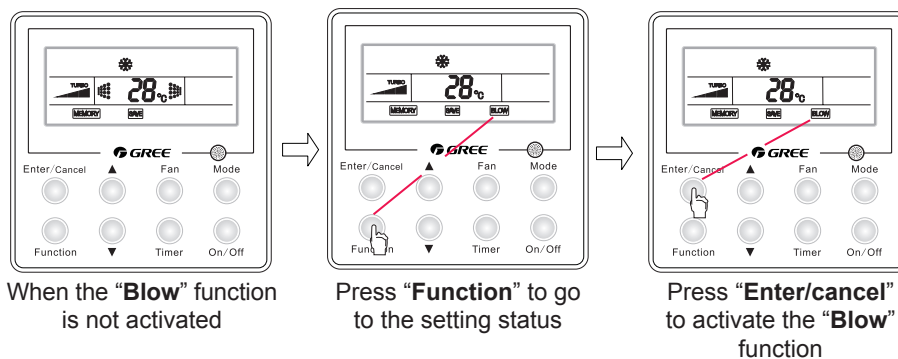

Fig. 22 How to Activate the “Blow” Function

See Fig. 23 for how to deactivate the “Blow” function .

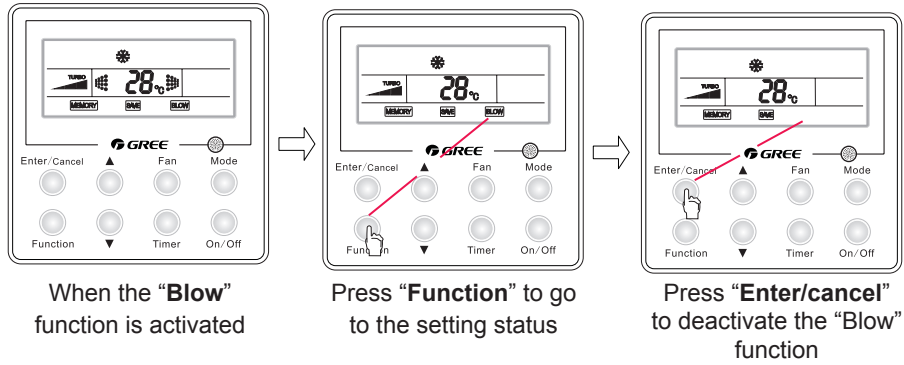

Fig.23 How to Deactivate the “Blow” Function

7.4.11 Quiet

There are two options for this function: “Quiet” and “Auto Quiet”.

How to activate the “Quiet” / “Auto Quiet” function: Press the “Function” key to go to the setting state with the symbol “” or “” flashing, then , press “▲” or “▼” to switch between “Quiet” and “Auto Quiet”, after that, press the “Enter/Cancel” key to make a confirmation.

How to deactivate the “Quiet”/“Auto Quiet” function : when the “Quiet”/“Auto Quiet” function is activated, press the “Function” key to go to the setting state with the symbol “” or “” flashing, after that, press “Enter/Cancel” to deactivate the “Quiet” function.

See Fig.24 for how to activate the “Quiet”/ “Auto Quiet” function.

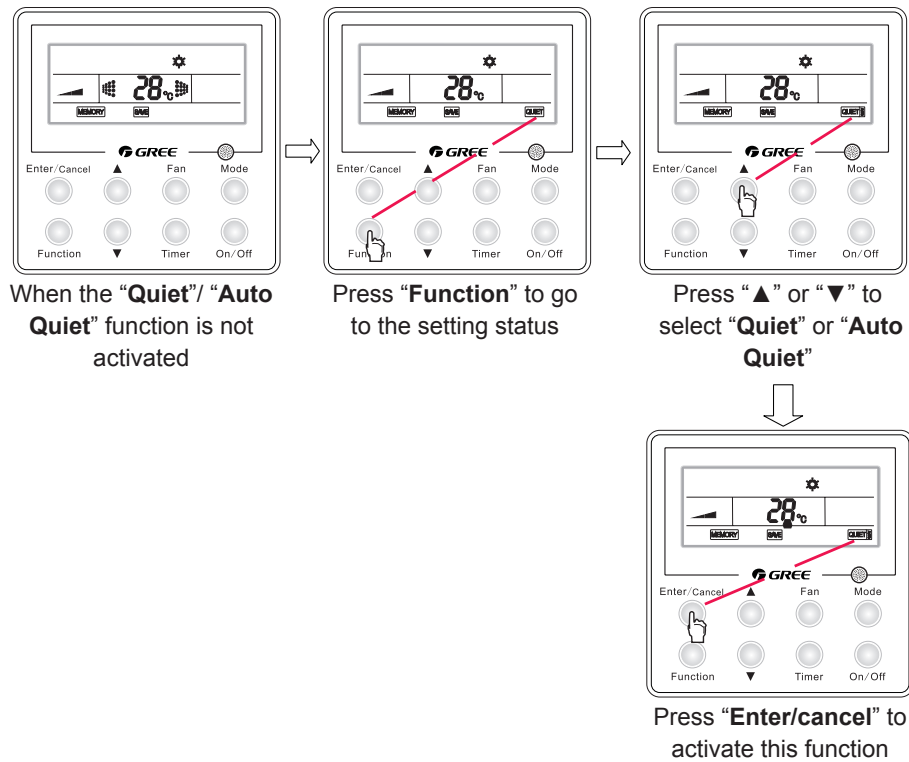

Fig. 24 How to Activate the “Quiet”/ “Auto Quiet” Function

See Fig. 25 for how to activate the “Quiet” function.

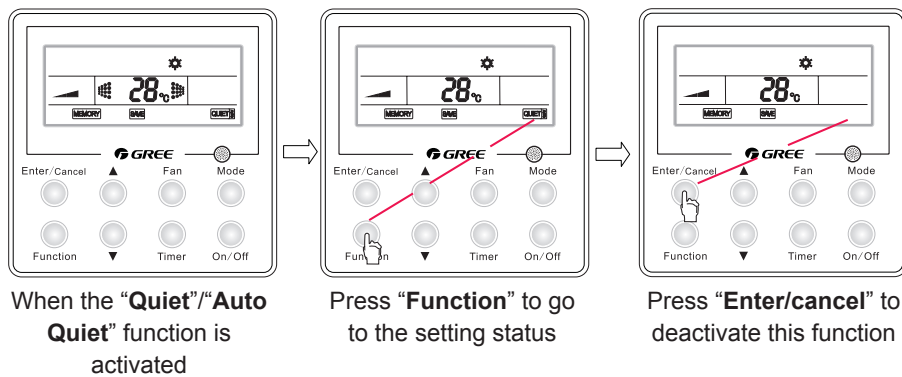

Fig.25 How to Deactivate the “ Quiet ”/“ Auto Quiet ” Function

NOTE:

- ① The fan speed is unadjustable when the “Quiet” function is activated .
- ② When the “Auto Quiet” function is activated, the unit will run into the “Quiet” status according to the actual indoor ambient temperature and user-set temperature. In this case, the fans speed is adjustable .
- ③ Under the “Auto Quiet” mode, the fan speed can only go down. And the “Quiet” function will quit automatically if the fan speed is adjusted manually .
- ④ The “Quiet” function is unavailable under the “Fan” and “Dry” modes. And the default status of the function is “Off” when the unit is powered on again .
- ⑤ The “Turbo” function will be deactivated automatically when the “Quiet” function is activated.

7.4.12 Debugging

When the unit is “Off”, press “Function” and “ Timer” simultaneously for five seconds to call out the debugging menu, after that , press “Mode” to select the desired submenu and then press “▲” or “▼” to set the parameter.

6.4.12.1 Ambient Temperature Sensor

Under the debugging condition, press the “Mode” to adjust the display to “00” in the temperature zone , and press “▲” or “▼” to adjust the display in the timer zone, for which there are three options :

- The indoor ambient temperature is the return air temperature . (“01” displayed)
- The indoor ambient temperature is the temperature which the wired controller senses. (“02” displayed)
- The return air temperature sensor is selected under the “Cool”, “Dry” or “Fan” mode . The temperature sensor of the wired controller is selected under the “Heat” mode . (“03” displayed)

6.4.12.2 Anti Cold/Hot Air Function



Under the debugging condition, press the “Mode” key to switch the display in the temperature zone to “03” and press “▲” or “▼” to switch the display in the timer zone. For the later display, there are two options: “ 01” indicating the unit with the anti cold/hot air functions, and “02” indicting the unit without the anti cold/hot air function .

Please press “Enter/Cancel” to save the setting and quit the setting status; otherwise if there is no operation in 20 seconds after the system responds to the last operation on the press button, and then the system will quit this setting status and back to the normal “Off” status with the current setting not saved.

7.4.13 Other Functions

7.4.13.1 Lock

Lock Function:It can lock the keypad and then the press on any other keys will get no response.

Whatever the unit is “On” or “Off”, press “▲” and “▼” simultaneously for five seconds to activate the “Lock” function and the symbol “” will appear. And then another press on them will deactivate this function and the symbol “” will disappear.

The “Lock” function will be memorized when the unit is powered on again after power failure.

7.4.13.2 Memory



“Memory” Function: When the “Memory” function is activated for the wired controller, the unit resume the status before powered off when it is powered on again; otherwise the unit will go to the “Off” status when it is powered on again.

How to switch to the “Memory” function: When the unit is “Off”, press “ Mode ” and “▲” simultaneously for five seconds to activate/deactivate the “Memory” function. Once the function is activated, the symbol will be displayed on the LCD.

NOTE:Please don't cut down the power after the content changes in five seconds, or it may fail to save the content.

7.4.14.3 Gate Control

When the gate control is effective, the unit will work with the card inserted in and will be shut down with the card drawn out.

When the card is drawn out, the unit will be shut down and the symbol“”will appear; when the card is inserted in again, the symbol“”will disappear and the unit will run as the previous state.

On condition that the “**Memory**” function is activated, when the wired controller is powered on again, the unit with the card inserted in will back to the previous state and the unit with the card drawn out will go to“**Off**” status.

On condition that the “**Memory**” function is deactivated, the unit will go to the “**Off**” state when the wired controller is powered on again.

NOTE:

- ① The card being inserted or not, the long-distance monitoring is always enabled.
- ② The displayed symbol“”indicates that the unit can not be controlled through the keys.

7.4.14.4 Switchover between Celsius and Fahrenheit Scale

When the unit is “**Off**”, it is able to switch the Celsius scale and Fahrenheit scale by pressing “**Mode**” and “**▼**” simultaneously for five seconds.

7.4.14.5 Long-distance Shield

On condition that all functions, or the function “**On/Off**”, “**Mode**”, “**Temperature**” or “**Save**” is shielded, the press on any key of the wired controller or the operation through the wireless controller will be ineffective but with the corresponding symbol flashing. For instance, if the “**Mode**” is shielded, then the operation to switch the current mode “**Cool**” to “**Heat**” would fail.

7.5 Error Display

When a system error arises, its error code will be displayed in the temperature zone. While if several errors occurs at the same time, their codes will be displayed circularly.

Once an error arises, please shut down the unit and contact the professional technician.

See Fig.26 for the communication error.

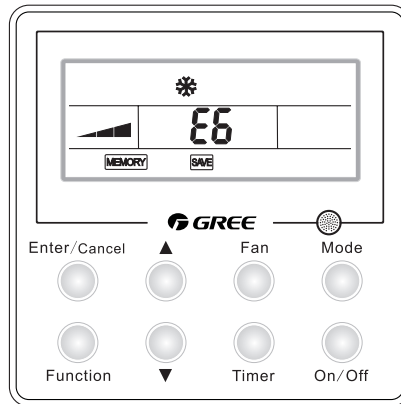

Fig. 26 Communication Error

Error list:

Error Code	Error Description
E0	Water pump error.
E6	Communication error.
E9	Water overflow protection.
F0	Error of Indoor ambient temperature sensor of return air inlet.
F1	Temperature sensor error of evaporator.
F5	Temperature sensor error of wired controller.
EH	Auxiliary electrical heater error.
C5	Jumper error.
H6	PG motor error.

INSTALLATION

INSTALLATION

1 INSTALLATION OF THE UNIT

1.1 Important Notices

(1) The unit installation work must be done by qualified personnel according to the local rules and this manual.

(2) Before installing, please contact with local authorized maintenance center, if unit is not installed by the authorized maintenance center, the malfunction may not be solved, due to discommodious contacts.

(3) When removing the unit to the other place, please firstly contact with the authorized Maintenance Center in the local area.

1.2 Basic Requirements For Installation Position

Install in the following place may cause malfunction. If it is unavoidable contact with service center please:

(1) Place where strong heat sources, vapors, flammable gas or volatile object are emitted.

(2) Place where high-frequency waves are generated by radio equipment, welders and medical equipment.

(3) Place where a lot of salinities such as coast exists.

(4) Place where the oil (machine oil) is contained in the air.

(5) Place where a sulfured gas such as the hot spring zones is generated.

(6) Other place with special circumstance.

1.3 Indoor Unit Installation Position Selection

(1) The air inlet and outlet vent should be far away from the obstruction.

(2) Select a position where the condensing water can be easily drained out.

(3) Select a location where the children can not reach.

(4) Select the place that is strong enough to withstand the full weight and vibration of the unit. And will not increase the noise.

(5) Be sure to leave enough space to allow access for routine maintenance. The height of the installed location should be 250cm or more from the floor.

(6) Select a place about 1m or more away from TV set or any other electric appliances.

(7) Select a place where the filter can be easily taken out.

(8) Make sure that the unit installation should accord with installation dimension diagram requirements.

(9) Do not use the unit in the immediate surroundings of a laundry a bath a shower or a swimming pool.

1.4 Safety Requirements For Electric Appliances

(1) The power supply should be used the rated voltage and AC exclusive circuit, the power cable diameter should be satisfied.

(2) Don't drag the power cable emphatically.

(3) It should be reliably earthed, and it should be connected to the special earth device, the installation work should be operated by the professional.

The air switch must have the functions of magnetic tripping and heat tripping, in order to protect the short circuit and overloading.

(4) The min. distance from the unit and combustive surface is 1.5m.

(5) The appliance shall be installed in accordance with national wiring regulations.

(6) An all-pole disconnection switch having a contact separation of at least 3mm in all poles should be connected in fixed wiring.

Note:

① Make sure that the Live wire or Zero line as well as the earth wire in the family power socket can not be wrong connected, there should be reliable and no short circuit in the diagram.

② Wrong connection may cause fire.

1.5 Earthing requirements

(1) Air conditioner is type I electric appliance, thus please do conduct reliable earthing measure.

(2) The yellow-green two-color wire in air conditioner is earthing wire and cannot be used for other propose. It cannot be cut off and be fix it by screw, otherwise it would cause electric shock.

(3) The earth resistance should accord to the National Criterion.

(4) The user power must offer the reliable earthing terminal. Please don't connect the earthing wire with the following place:

① Tap water pipe ② Gas pipe ③ Contamination pipe.

④ Other places that professional personnel consider them unreliable.

(5) The model and rating values for fuses according the silk print on fuse cover or related PCB board.

2 INSTALLATION DIMENSION DIAGRAM

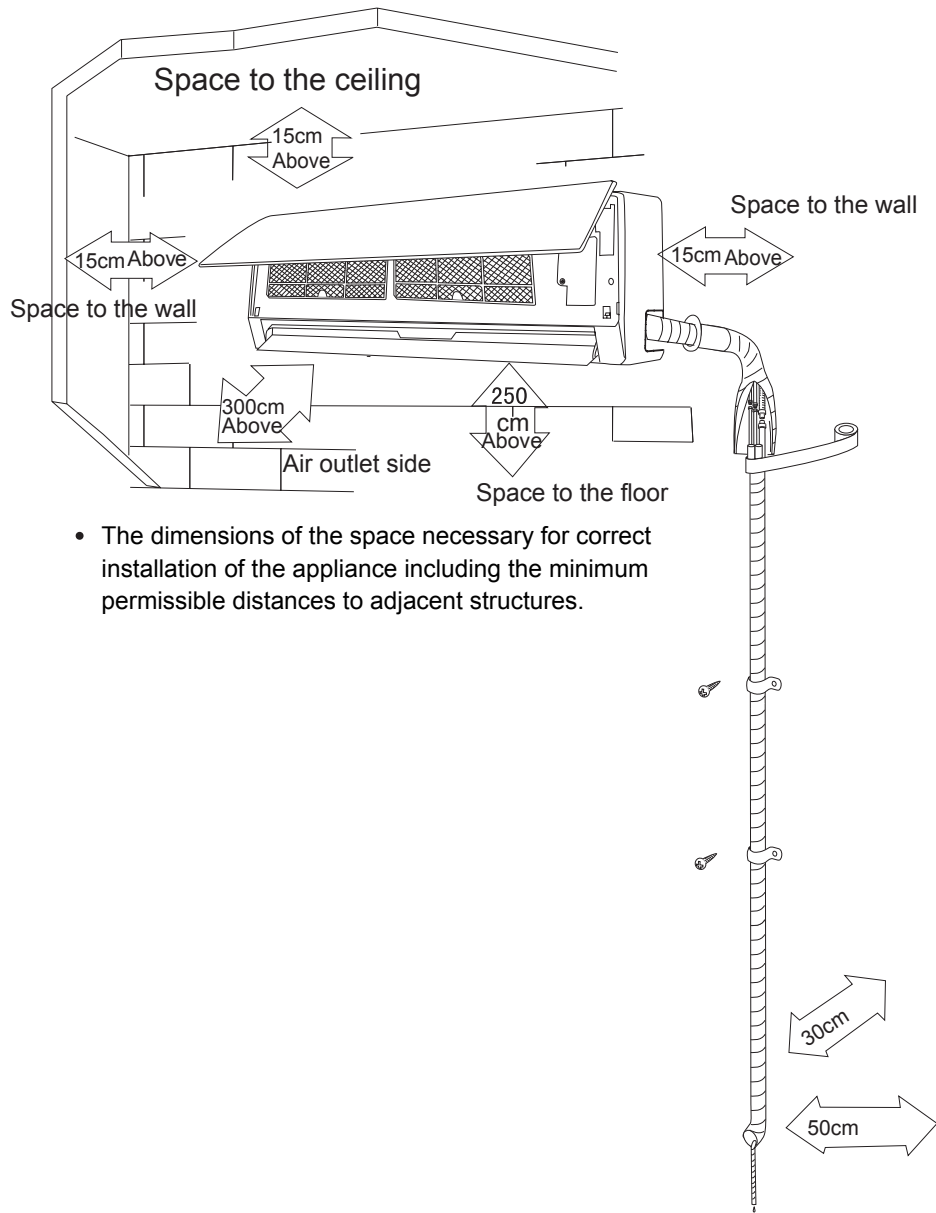

3 INSTALL THE UNIT

3.1 Install the rear panel

(1) Always mount the rear panel horizontally. Due to the water tray of indoor unit has been adopted the both-way drainage design, the outlet of water tray should be adjusted slightly down when installing, that is taking the outlet of the water tray as the center of a circle, the included angle between the evaporator and level should be 0 or more, that is good for condensing water drainage.

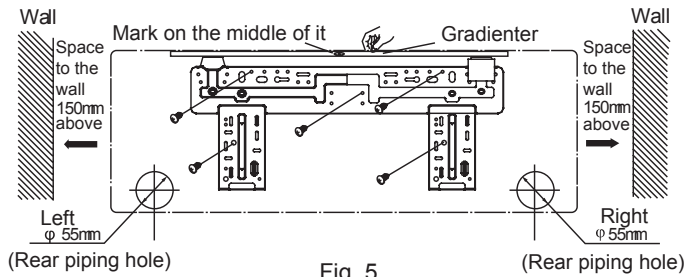

Fig. 5

(2) Fix the rear panel on the wall with screws. (Where is pre-covered with plastic granula)

(3) Be sure that the rear panel has been fixed firmly enough to withstand the weight of an adult of 60kg, further more, the weight should be evenly shared by each screw.

3.2 Install the piping hole

① Ake the piping hole (Φ55) in the wall at a slight downward slant to the outdoor side.

② Insert the piping-hole sleeve into the hole to prevent the connection piping and wiring from being damaged when passing through the hole.

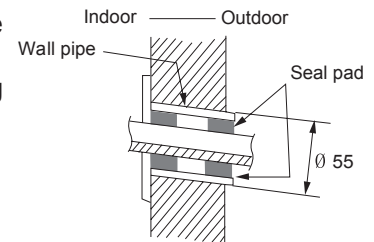

3.3 Install the water drainage pipe

(1) For well draining, the drain hose should be placed at a downward slant.

(2) Do not wrench or bend the drain hose or flood its end by water. (As show in Fig.6)

(3) When the long drainage hose passing through indoor, should wrap the insulation materials.

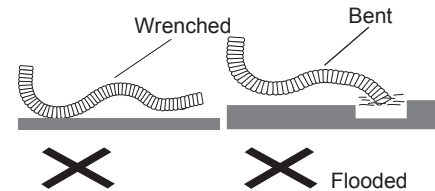

Fig.6

Note:

When connecting the electric wire if the wire length is not enough, please contact with the authorized service shop to buy a exclusive electric wire that is long enough and the joint on the wire are not allowed.

- The electric wiring must be correctly connected, wrong connection may cause spare parts malfunction.

- Tighten the terminal screw in order to prevent loose.

- After tighten the screw, slight pull the wire and confirm whether is it firm or not.

- If the earth wire is wrong connection, that may cause electric shock.

- The cover plate must be fixed, and tighten the connection wire, if it is poor installed, that the dust, moisture may enter in or the connection terminal will be affected by outside force, and will cause fire or electric shock.

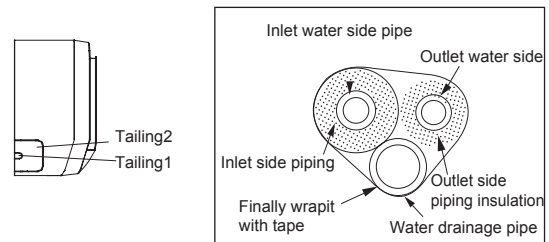

Fig.7

3.4 Install the unit

- The piping can be lead out from right, right rear, left ,left rear.

(1) When routing the piping and wiring from the left or right side of indoor unit, cut off the tailings from the chassis in necessary(Show in Fig.7)

1) Cut off the tailings 1 when routing the wiring only;

2) Cut off the tailings 1 and tailings 2 when routing both the wiring and piping.

(2) Take out the piping from body case, wrap the piping electric wire, water pipe with tape and pull them through the piping hole (as show in Fig.8)

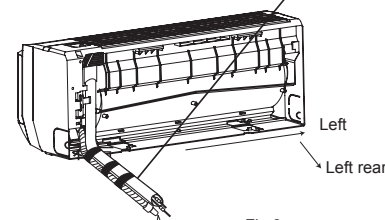

Fig.8

(3) Hang the mounting slots of the unit on the upper tabs of the rear panel and check if it is firm enough.(As show in Fig.9)

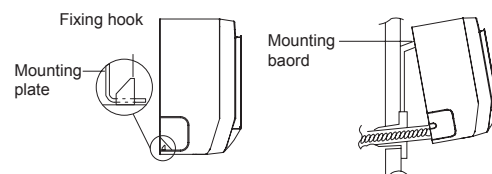

Fig.9

(4) The height of the installed location should be 2.5 m or more from the floor.

3.5 Install the connection pipe

- (1) Align the center of the piping flare with the relevant valve.
- (2) Screw in the flare nut by hand and then tighten the nut with spanner and torque wrench refer to the following:

Hex nut diameter	Tightening torque (N·m)
Φ6	15~20
Φ 9.52	31~35
Φ 12	50~55
Φ 16	60~65
Φ 19	70~75

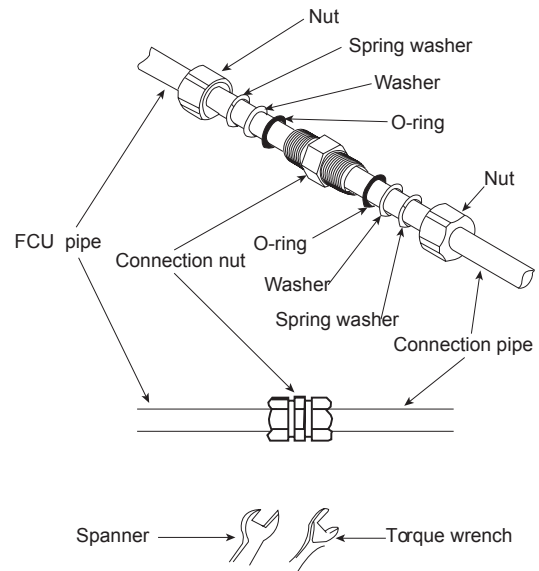
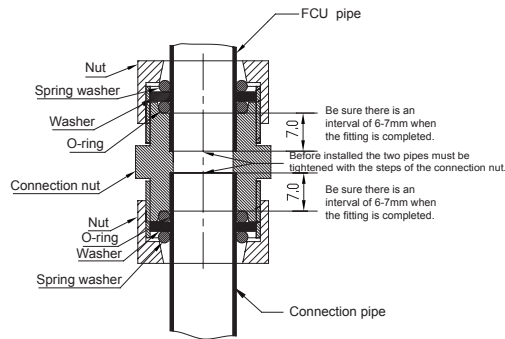

3.6 The way of operating vent valve

3.6.1 Check after installation

When necessary to operating the vent valve, the steps should operate as follow:

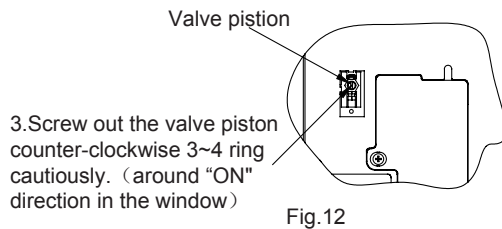
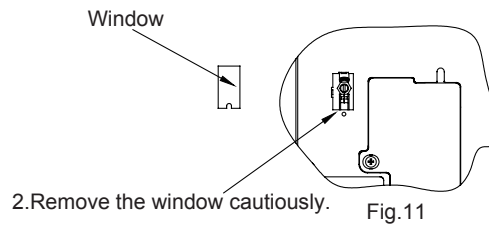
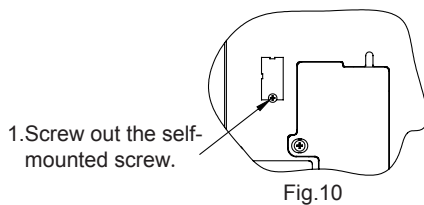

4. Run the FCU
After running, fit in the parts as follow.
- (1) Screw the valve piston clockwise properly before operation. (around "OFF" direction in the window)
 - (2) Reinstall the window.
 - (3) screw the self-mounted screw.

3.7 Check after installation and test operation

3.7.1 Check after installation

Items to be checked	Possible malfunction
Has it been fixed firmly?	The unit may drop, shake or emit noise.
Is heat insulation sufficient?	It may cause condensation and dripping.
Is water drainage well?	It may cause condensation and dripping.
Is the voltage in accordance with the rated voltage marked on the nameplate?	It may cause electric malfunction or damage the part.
Is the electric wiring and piping connection installed correctly and securely?	It may cause electric malfunction or damage the part.
Has the unit been connected to a secure earth connection?	It may cause electrical leakage.
Is the power cord specified?	It may cause electric malfunction or damage the part.
Is the inlet and outlet been covered?	It may cause insufficient cooling (heating) capacity.

3.7.2 Test Operation

- (1) Before test operation
 - 3) Do not switch on power before installation is finished completely.
 - 4) Electric wiring must be connected correctly and securely.
 - 5) All the impurities such as scraps and thrums must be cleared from the unit.
- (2) Test operation method
 - 6) Switch on power, press "ON/OFF" button on the wireless remote control to start the operation.
 - 7) Press MODE button, to select the COOL, HEAT, FAN to check whether the operation is normal or not.

MAINTENANCE

MAINTENANCE

1 TROUBLESHOOTING

1.1 CAUTION

Don't attempt to repair the air conditioner by yourself. It can cause an electric shock or fire. Please check the following items before asking for repair, it can save your time and money.

Phenomenon	Troubleshooting
Not operate immediately when the air conditioner is restarted.	Once the air conditioner is stopped, it will not operate in approximately 3minutes to protect itself
There's unusual smell blowing from the outlet after operation is started.	The unit has no peculiar smell by itself. If has, that is due to the smell accumulated in the ambient. Solution method: Cleaning the filter. If problem still has, so need to clean air conditioner. (Please contact with the authorized maintenance center.)
Sound of water flow can be heard during the operation.	The sound is due to water flowing they are not malfunctions.
In COOL mode, sometimes the mist emitted from the air outlet vent.	When the indoor temperature and humidity are very high, this phenomenon would happen. This is caused by the room air is swiftly cooled down. After running for a while, indoor temperature and humidity will fall down, the mist will die away.
Creaking noise can be heard when start or stop the unit.	This is caused by the deformation of plastic due to the changes of temperature.
The unit can not run.	Has the power been shut down? Is power plug loosed? Is the circuit protection device tripped off or not? Is voltage higher or lower? (Tested by professionals) Is the TIMER correctly used?
Cooling(Heating) efficiency is not good.	Is Temp setting suitable? Were inlet and outlet vents obstructed? Is filter dirty? Are the windows and doors clothed? Did Fan speed set at low speed? Is there any heat sources in the room?
Wireless remote control is not available.	The unit is interfered by abnormal or frequent functions switchover occasionally the controller cannot operate. At this time, you need to pull out of the plug, and reinsert it. Is it in its receiving range? Or obstructed? To check the voltage in wireless remote control inside is charged, otherwise to replace the batteries. Whether the wireless remote control is damaged.
Water leaks in the room.	The air humidity is on the high side. Condensing water over flowed. The connection position of indoor unit drainage pipe is loosed.
Indoor unit cannot deliver air.	In HEAT mode, when the temperature of indoor heat exchanger is very low, that will stop deliver air in order to prevent cool air (within 2min). In COOL mode, when the temperature of indoor heat exchanger is very high, that will stop deliver air in order to prevent heat air(within 2min).
Moisture on air outlet vent.	If unit is running under the high humidity for a long time, the moisture will be condensed on the air outlet grill and drip off.
Cooling LED blinks and display F0.	F0:Ambient temperature sensor is open or short-circuit. Please cut off power at first and then check whether the wires of ambient temperature sensor have been disconnected with the main board. If there are disconnected, please insert the ambient temperature sensor and then check whether it can run normally after power on. If it still can't run normally, please replace the ambient temperature sensor.
Cooling LED blinks and display F1.	F1: Aluminum fin-copper tube temperature sensor is open or short-circuit. Please cut off power at first and then check whether the wires of tube temperature sensor have been disconnected with the main board. If there are disconnected, please insert the tube temperature sensor and then check whether it can run normally after power on. If it still can't run normally, please replace the tube temperature sensor.
Running LED blinks and displays C5.	C5: Malfunction protection of the jumper cap. Please cut off power at first and then check whether the cap jumper has been inserted well.
Running LED blinks and displays H6.	H6: No motor feed back. Please cut off power at first and then restart the unit to check whether it can run normally or not.

- Immediately stop all operations and plug out, contact the dealer in following situations.
- There is harsh sound during operation.
- The terrible odors emitted during operation.
- Water is leaking in the room.
- Air switch or protection switch often breaks.
- Carelessly splash water or something into the unit.
- There is an abnormal heat in power supply cord and power plug.

2 MAINTENANCE INSTRUCTIONS

Forcibly pull the panel for a specific angle from the two ends of the front panel according to the arrow direction. Then pull the air filter downwards to remove it. (See Fig. a Mount the healthy filter onto the air filter,(as shown in Fig. b). If the air filter cannot be installed, please mount the healthy filter on the front case. (as shown in Fig. c)

Mount the air filter properly along the arrow direction in Fig. d, and then close the panel cover.

2.1 Cleaning and Maintenance

Take out the healthy filter before cleaning and reinstall it after cleaning according to the installation instruction. Pay special attention to that silver ion filter can't be cleaned with water, while active carbon, photocatalyst , low temperature conversion (LTC) catalyst, formaldehyde eliminator, catechin or mite killing filter can, but can't with brush or hard things. Dry it in the shade or sun after cleaning, but not by wiping.

2.2 Service Life

The healthy filter commonly has its usage lifetime for one year under normal condition. As for silver ion filter, it is invalid when its surface becomes black (green).

This supplementary instruction is provided for reference to the unit with healthy filter. If the graphics provided herein is different from the physical goods, the latter one shall prevail. The quantity of healthy filters shall be based on the actual delivery.

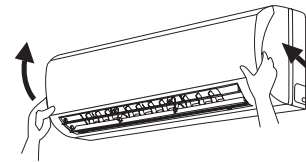

Fig.a

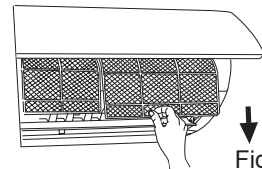
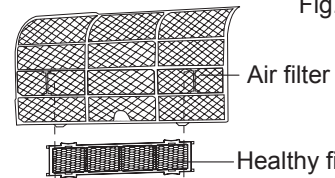

Fig.b



Air filter

Healthy filter

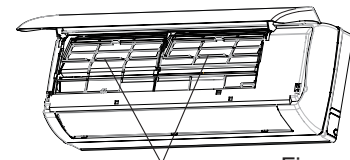

Fig.c

Healthy filter

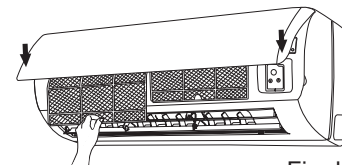
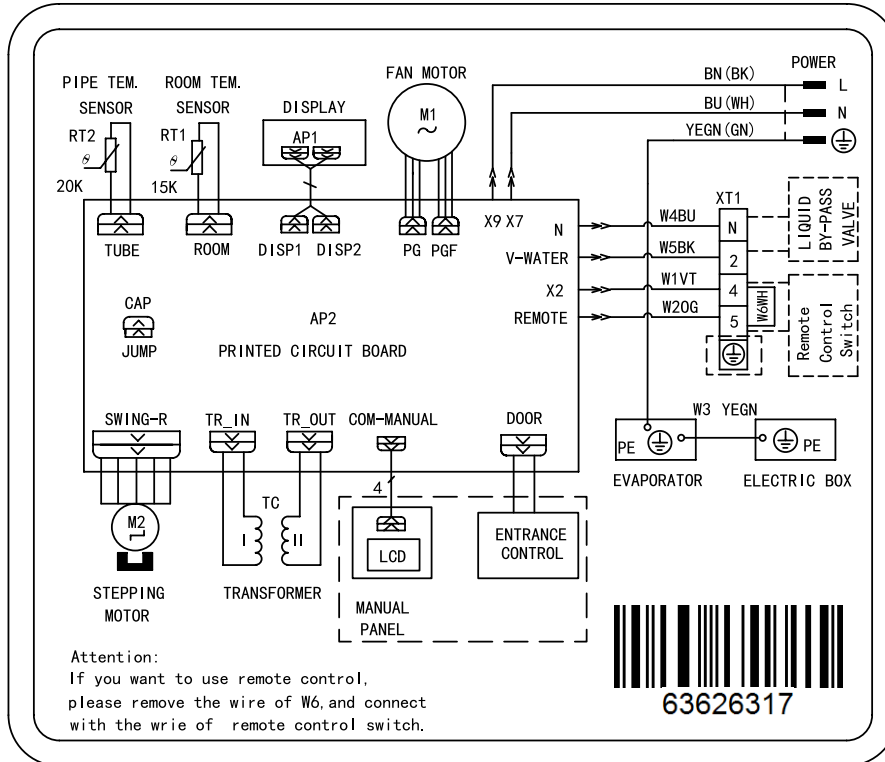

Fig.d

3 WIRING DIAGRAMS

FP-34BA2/B-D, FP-51BA2/B-D, FP-68BA2/B-D, FP-85BA2/B-D, FP-102BA2/B-D, FP-34BA3/B-D, FP-51BA3/B-D, FP-68BA3/B-D, FP-85BA3/B-D, FP-102BA3/B-D, FP-34BA2/D-K, FP-51BA2/D-K, FP-68BA2/D-K, FP-85BA2/D-K, FP-34BA3/D-K, FP-51BA3/D-K, FP-68BA3/D-K, FP-85BA3/D-K, FP-34BA4/D-K, FP-51BA4/D-K, FP-68BA4/D-K, FP-85BA4/D-K, FP-34BA5/D-K, FP-51BA5/D-K, FP-68BA5/D-K, FP-85BA5/D-K, FP-34BA2/D-K(E), FP-34BA3/D-K(E), FP-34BA4/D-K(E), FP-34BA5/D-K(E), FP-51BA2/D-K(E), FP-51BA3/D-K(E), FP-51BA4/D-K(E), FP-51BA5/D-K(E), FP-68BA2/D-K(E), FP-68BA3/D-K(E), FP-68BA4/D-K(E), FP-68BA5/D-K(E), FP-85BA2/D-K(E), FP-85BA3/D-K(E), FP-85BA4/D-K(E), FP-85BA5/D-K(E), FP-34BB3/A-K(E), FP-51BB3/A-K(E)



FP-68BA2/A-K, FP-85BA2/A-K

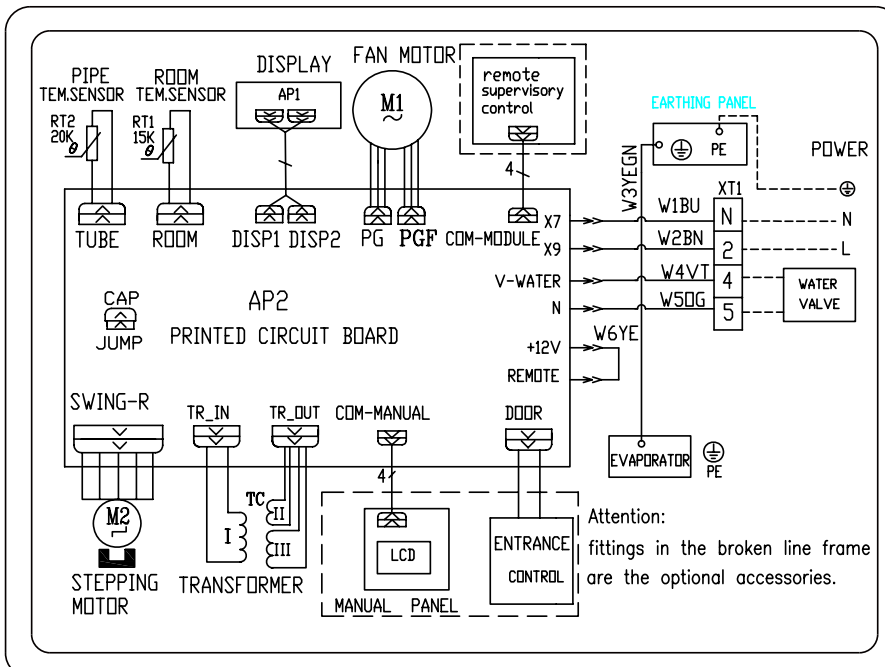

FP-51BWA2/A-K(E), FP-51BWA3/A-K(E), FP-85BWA2/A-K(E), FP-85BWA3/A-K(E).

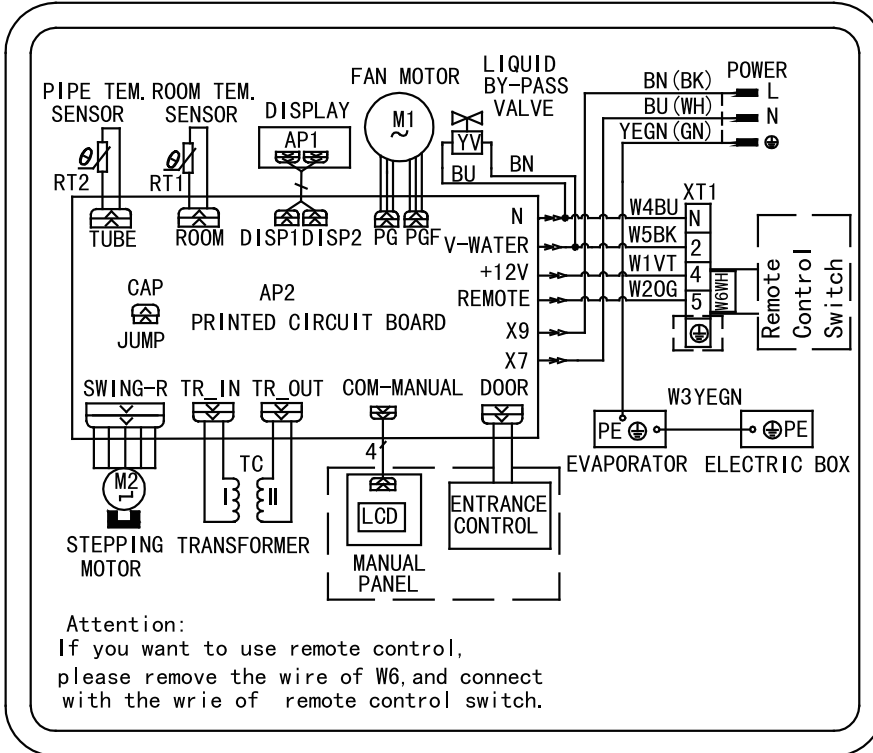

FP-85BWA2/A-K

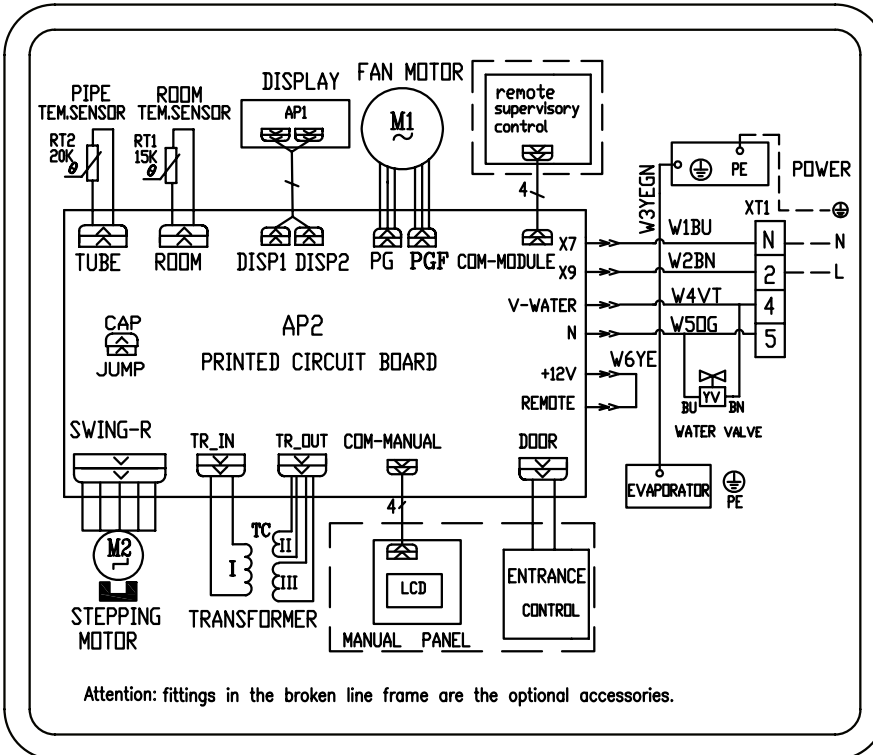

FP-34BA5/B-D, FP-51BA5/B-D, FP-68BA5/B-D, FP-85BA5/B-D, FP-102BA5/B-D

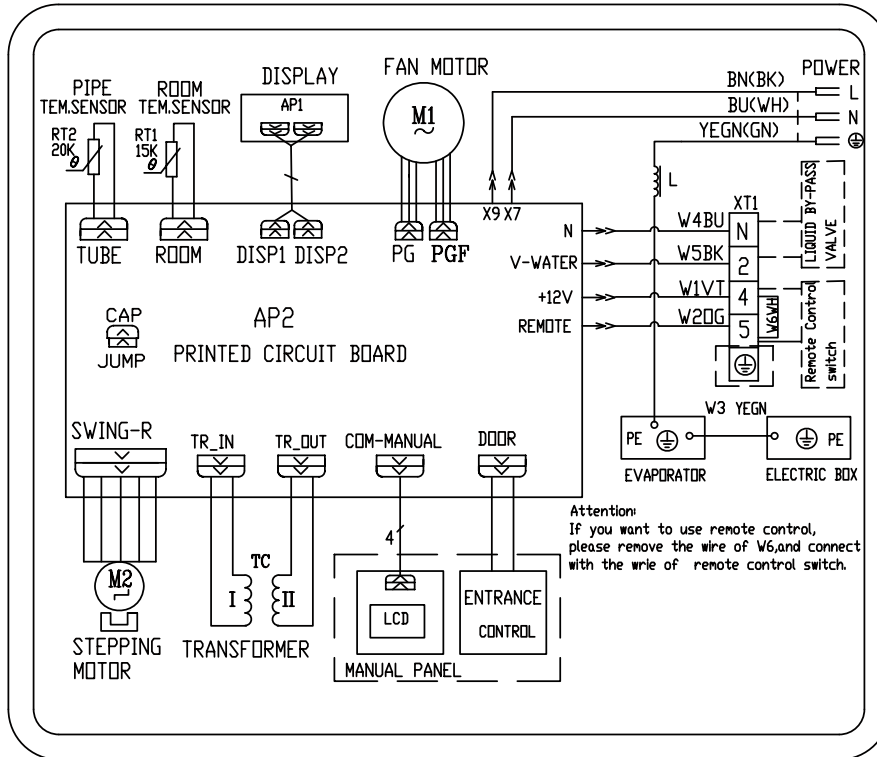

FP-34BA3/B-K, FP-51BA3/B-K, FP-68BA3/B-K, FP-85BA3/B-K

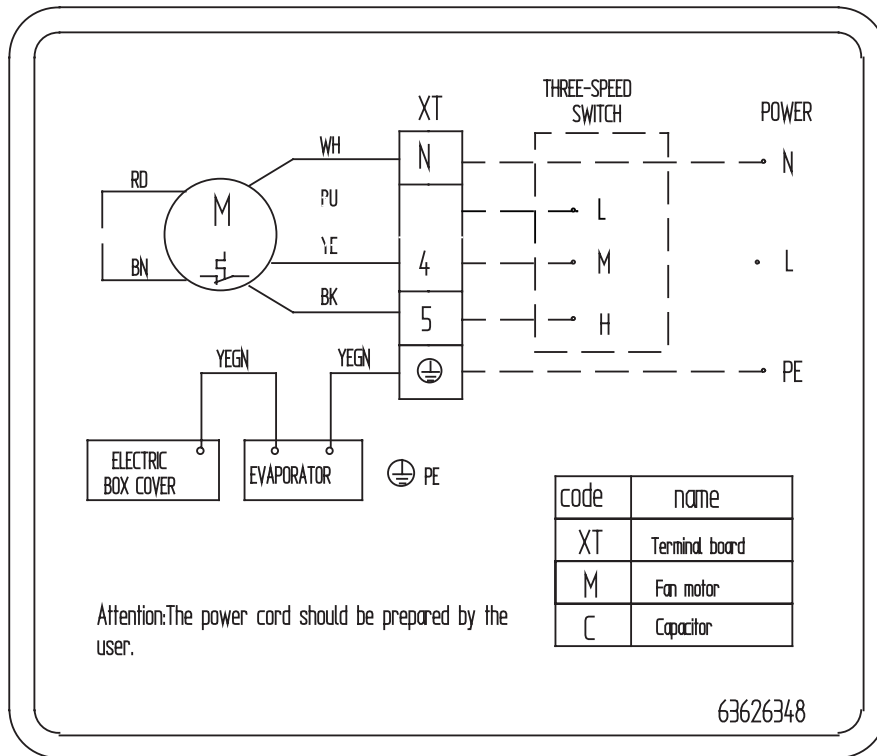

FPD-34BB3/A-K FPD-51BB3A-K FPD-68BB3A-K FPD-85BB3/A-K

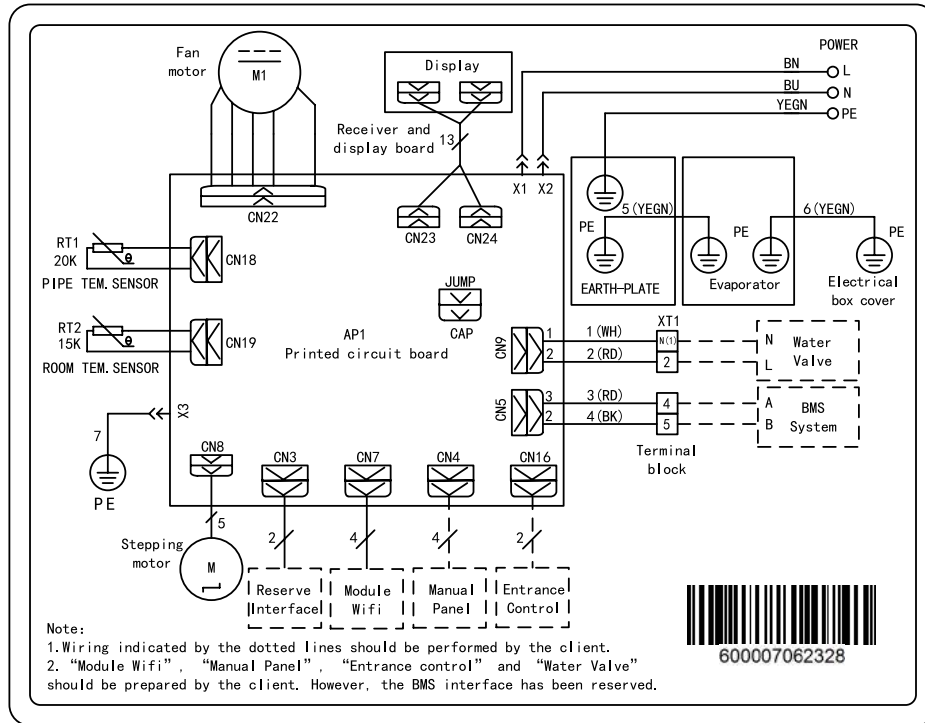

600007062328

4 EXPLODED VIEWS AND SPARE PART LISTS

Model: FP-34BA2/A-K(EM55000200), FP-51BA2/A-K(EM55000210), FP-34BA3/A-K(EM55001130), FP-51BA3/A-K(EM55001210), FP-34BA4/A-K(EM55001140), FP-51BA4/A-K(EM55001220), FP-34BA5/A-K (EM55000260), FP-51BA5/A-K(EM55000270), FP-34BB3/A-K(EM55001180), FP-51BB3/A-K(EM55001260) , FP-34BA2/D-K(EM55001810), FP-51BA2/D-K(EM55001820), FP-34BA3/D-K(EM55002000), FP-51BA3/D-K(EM55002010), FP-34BA4/D-K(EM55002040), FP-51BA4/D-K(EM55002050), FP-34BA5/D-K(EM55002080), FP-51BA5/D-K(EM55002090), FP-34BA2/D-K(E)(EM55002370), FP-34BA3/D-K(E)(EM55002380), FP-34BA4/D-K(E)(EM55002390), FP-34BA5/D-K(E)(EM55002400), FP-51BA2/D-K(E)(EM55002410), FP-51BA3/D-K(E)(EM55002420), FP-51BA4/D-K(E)(EM55002430), FP-51BA5/D-K(E)(EM55002440)

Exploded Views:

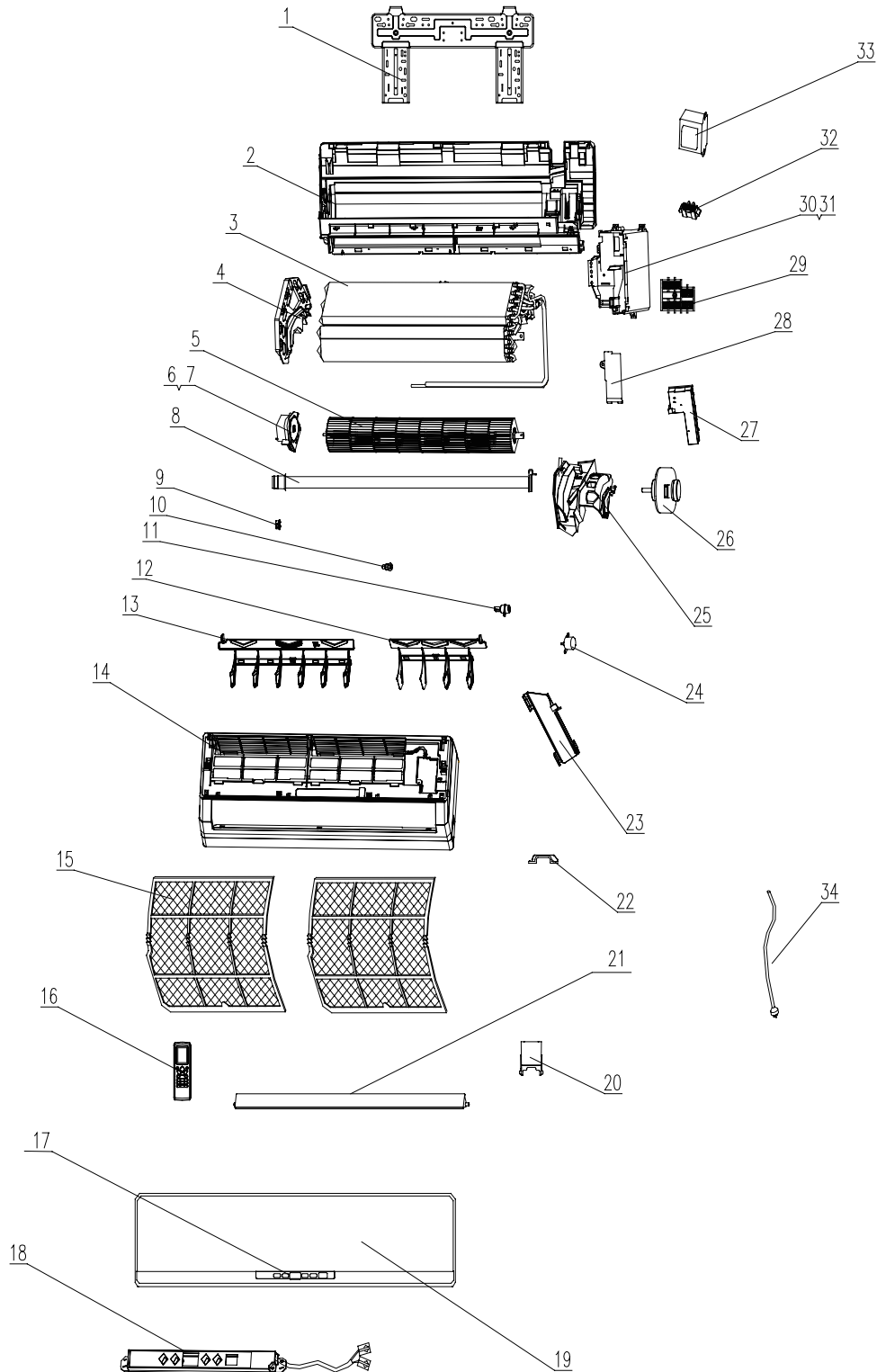

Spare parts list:

No.	Name of part	Part code	Quantity	No.	Name of part	Part code	Quantity
1	Wall-Mounting Frame	01252021	1	18	Display Board	30565056 ① ②	1
						30565007 ③ ④	
						30565012 ⑤ ⑥	
						30565026 ⑦ ⑧	
						30565037 ⑨ ⑩	
2	Rear Case	2220245401	1	19	Front Panel	20012150S ① ②	1
						20012122S ③ ④	
						20012153S ⑤ ⑥	
						20012199S ⑦ ⑧	
						20012202 ⑨ ⑩	
3	Evaporator Assy	01126406	1	20	Screw Cover	24252016	1
4	Evaporator Support	24212091	1	21	Guide Louver	10512157	1
5	Cross Flow Fan	10352017	1	22	Wire Clamp	71010003	1
6	Ring of Bearing	26152022	1	23	Rear Clamp	26112164	1
7	Bearing cushion rubber base	76512203	1	24	Motor MP24AA	1521210801	1
8	Volute tongue	26112163	1	25	Motor Clamp	26112161	1
9	Left Axile Bush	10512037	1	26	Motor FN20J-PG	150120874	1
10	Crank	10582070	1	27	Electric Box Cover 1	20122103	1
11	Axile Bush	10542008	1	28	Covering Plate2	20122075	1
12	Swing Louver1	10512156	1	29	Terminal Board	42010262	1
13	Swing Louver2	10512155	1	30	Electric Box	20112082	1
14	Front Case	20012123	1	31	Main PCB Z5P251A	30225043	1
15	Filter	1112220401	2	32	Jumping Connector	4202300117 ① ③ ⑤ ⑦ ⑨	1
16	Remote Control YB1FA	30510041	1			4202300125 ② ④ ⑥ ⑧ ⑩	
17	Decorate Piece	20192265 ① ②	1	33	Transformer 48X26G	43110233	1
		22432230 ③ ④					
		2019223601 ⑤ ⑥					
		20192247 ⑦ ⑧					
		27219900310 ⑨ ⑩					
				34	Power Cable	400220112	1

Note:

① is part of FP-34BA2/A-K,FP-34BA2/D-K,FP-34BA2/D-K(E) ; ② is part of FP-51BA2/A-K,FP-51BA2/D-K,FP-51BA2/D-K(E) ; ③ is part of FP-34BA3/A-K,FP-34BA3/D-K,FP-34BA3/D-K(E) ; ④ is part of FP-51BA3/A-K,FP-51BA3/D-K,FP-51BA3/D-K(E); ⑤ is part of FP-34BA4/A-K,FP-34BA4/D-K,FP-34BA4/D-K(E) , ⑥ is part of FP-51BA4/A-K,FP-51BA4/D-K,FP-51BA4/D-K(E); ⑦ is part of FP-34BA5/A-K,FP-34BA5/D-K,FP-34BA5/D-K(E) ; ⑧ is part of FP-51BA5/A-K,FP-51BA5/D-K,FP-51BA5/D-K(E) ; ⑨ is part of FP-34BB3/A-K;⑩ is part of FP-51BB3/A-K.

Model:FP-51BWA2/A-K(E) (EM55002310), FP-51BWA3/A-K(E) (EM55002320)
Exploded Views:

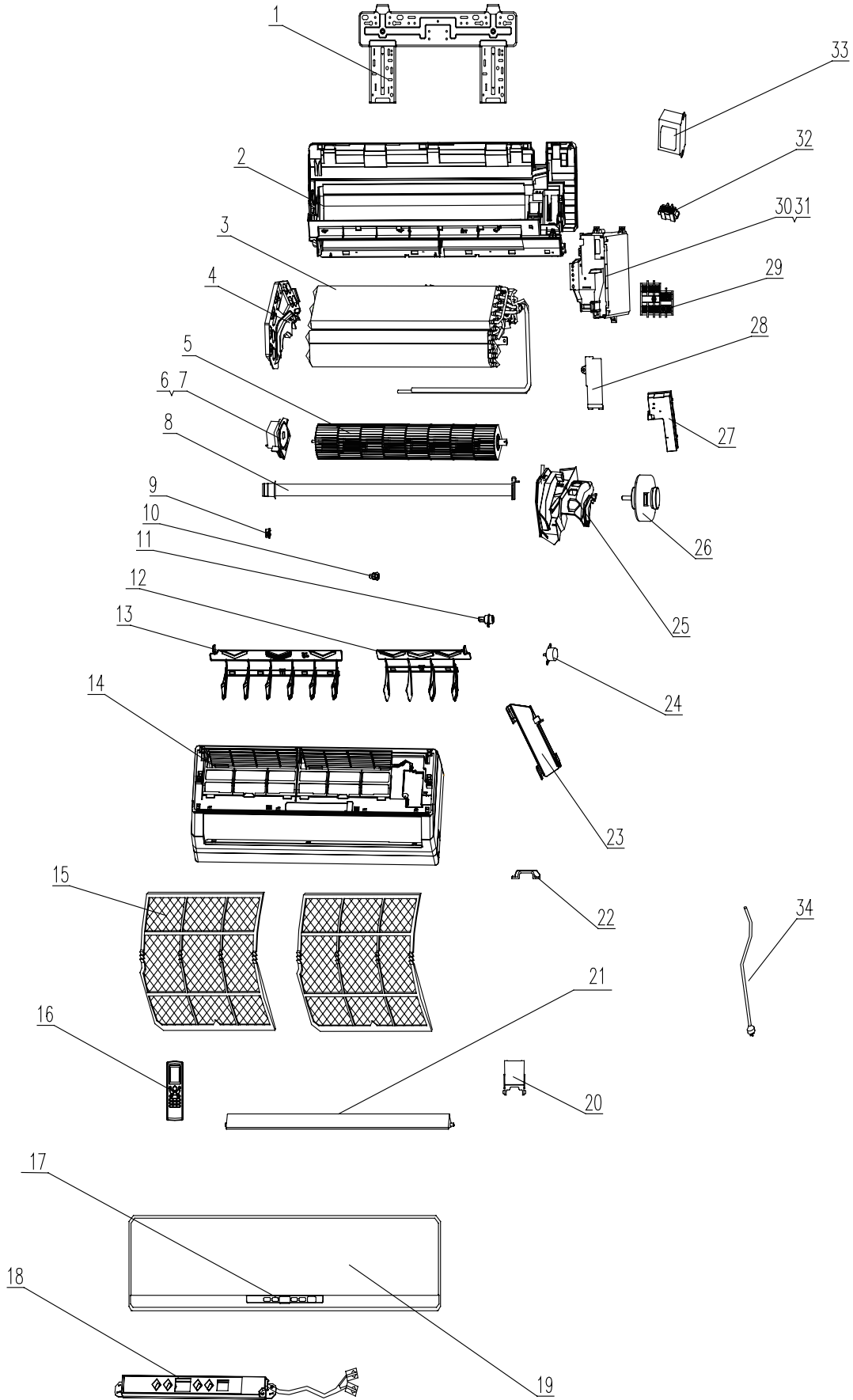

Spare parts list:

FP-51BWA2/A-K(E) (EM55002310), FP-51BWA3/A-K(E) (EM55002320)

No.	Name of part	Part code	Quantity	No.	Name of part	Part code	Quantity
1	Wall-Mounting Frame	01252013 ①	1	18	Display Board	30565056 ①	1
		01252021 ②				30565026 ②	
2	Rear Case	2220245401	1	19	Front Panel	20012150S	1
3	Sufer Cooler Assy	1126406	1				
4	Evaporator Support	24212091	1	20	Screw Cover	24252016	1
5	Cross Flow Fan	10352017	1	21	Guide Louver	10512157	1
6	Ring of Bearing	26152022	1	22	Wire Clamp	71010003	1
7	Bearing cushion rubber base	76512203	1	23	Rear Clamp	26112164	1
8	Volute tongue	26112163	1	24	Motor MP24AA	1521210801	1
9	Left Axile Bush	10512037	1	25	Motor Clamp	26112161	1
10	Crank	10582070	1	26	Motor FN20J-PG	150120874	1
11	Axile Bush	10542008	1	27	Electric Box Cover 1	20122103	1
12	Swing Louver1	10512156	1	28	Covering Plate2	20122075	1
13	Swing Louver2	10512155	1	29	Terminal Board	42010262	1
14	Front Case	20012123	1	30	Electric Box	20112082	1
15	Filter	1112220401	2	31	Main PCB Z5P251A	30225043	1
16	Remote Control YB1FA	30510041	1	32	Jumping Connector	4202300129	1
17	Decorate Piece	20192265 ①	1	33	Transformer 48X26G	43110233	1
		20192247 ②		34	Power Cable	400220112	1

Note:

① is part of FP-51BWA2/A-K(E) only.

② is part of FP-51BWA3/A-K(E) only.

Model: FP-34BA3/B-K (EM55001720), FP-51BA3/B-K(EM55001730)
Exploded Views:

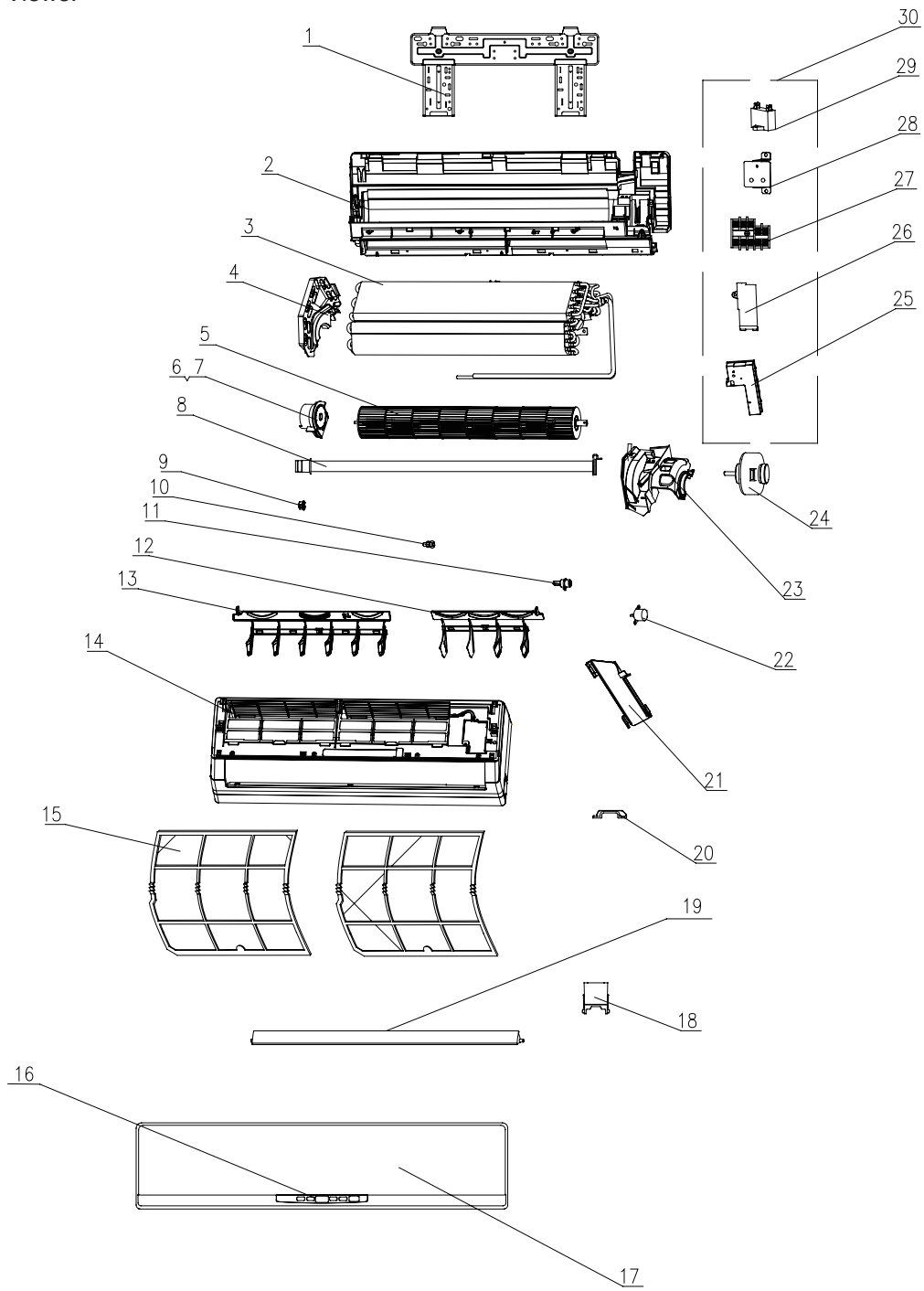

Spare parts list:
FP-34BA3/B-K (EM55001720)

No.	Name of part	Part code	Quantity
1	Wall-Mounting Frame	01252021	1
2	Rear Case	2220245401	1
3	Surface-Cooler Assy	01127669	1
4	Evaporator Support	24212091	1
5	Cross Flow Fan	10352017	1
6	Ring of Bearing	76512051	1
7	Bearing cushion rubber base	76512203	1
8	Volute Tongue	26112163	1
9	Left Axile Bush	10512037	1
10	Crank	10582070	1
11	Axile Bush	10542036	1
12	Swing Louver1	10512156	1
13	Swing Louver2	10512155	1
14	Front Case	2001212301	1
15	Filter Assy	1112220401	2
16	Decorate Piece	22432230 ① 20192265 ② / ③	1
17	Front Panel	20012122 ① 20012150 ② 20012199 ③	1
18	Guide Louver	10512157	1
19	Screw Cover	24252016	1
20	Wire Clamp	71010003	1
21	Rear Clamp	26112164	1
22	Stepping Motor	1521212901	1
23	Motor Clamp	26112161	1
24	Motor	15706432	1
25	Electric Box Cover 1	20122103	1
26	Electric Box Cover 2	20122075	1
27	Terminal Board	42010262	1
28	Installation Supporting Frame	01806868	1
29	Capacitor	33010089	1
30	Electric Box	01396952	1

Notes:

① only is part of FP-34BA3/B-K.

Spare parts list:
FP-51BA3/B-K(EM55001730)

No.	Name of part	Part code	Quantity
1	Wall-Mounting Frame	01252021	1
2	Rear Case	2220245401	1
3	Surface-Cooler Assy	01127669	1
4	Evaporator Support	24212091	1
5	Cross Flow Fan	10352017	1
6	Ring of Bearing	76512051	1
7	Bearing cushion rubber base	76512203	1
8	Volute Tongue	26112163	1
9	Left Axile Bush	10512037	1
10	Crank	10582070	1
11	Axile Bush	10542036	1
12	Swing Louver1	10512156	1
13	Swing Louver2	10512155	1
14	Front Case	2001212301	1
15	Filter Assy	1112220401	2
16	Decorate Piece	22432230 ①③ 20192265 ②	1
17	Front Panel	20012122 20012150 20012199	1
18	Guide Louver	10512157	1
19	Screw Cover	24252016	1
20	Wire Clamp	71010003	1
21	Rear Clamp	26112164	1
22	Stepping Motor	1521212901	1
23	Motor Clamp	26112161	1
24	Motor	15706434	1
25	Electric Box Cover 1	20122103	1
26	Electric Box Cover 2	20122075	1
27	Terminal Board	42010262	1
28	Installation Supporting Frame	01806868	1
29	Capacitor	33010089	1
30	Electric Box	01396952	1

Notes:

① only is part of FP-51BA3/B-K.

Model: FP-68BA3/B-K (EM55001750), FP-85BA3/B-K (EM55001740)
Exploded views:

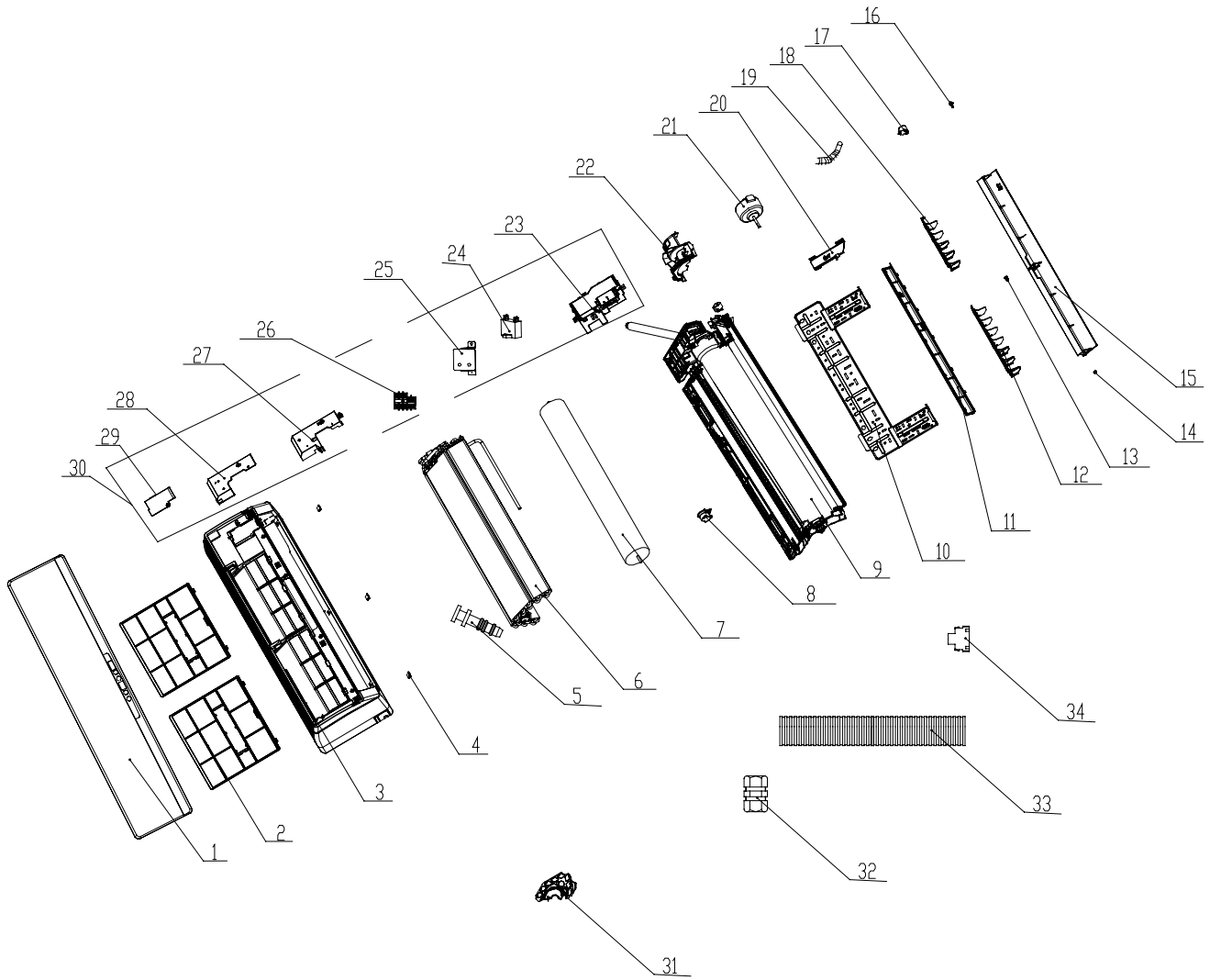

Spare parts list:
FP-68BA3/B-K (EM55001750)

No.	Name of part	Part code	Quantity
1	Front Panel Assy	20012260 ① 20012283 ② 20012286 ③	1
2	Filter Sub-Assy	1112208901	2
3	Front Case	2690603901	1
4	Screw Cover	24252016	1
5	Rubber Plug (Water Tray)	76712012	1
6	Surface Cooler Assy	01126656	1
7	Cross Flow Fan	10352019	1
8	Ring of Bearing	76512051	1
9	Rear Case assy	1231221408	1
10	Wall Mounting Frame	01252218	1
11	Volute tongue	26112238	1
12	Air Louver 1	10512116	1
13	Axile Bush	10542036	1
14	Left Axile Bush	10512037	1
15	Guide Louver	10512115	1
16	Crank	10582070	1
17	Stepping Motor	15012086	1
18	Swing Louver2	10512117	1
19	Drainage hose	05230014	1
20	Rear Clamp	26112164	1
21	Motor	1570643301	1
22	Motor Press Plate	26112494	1
23	Electric Box	20112108	1
24	Capacitor	33010020	1
25	Installation Supporting Frame	01806867	1
26	Terminal Board	42010262	1
27	Electric Box Cover 1	20122154	1
28	Shield cover of Electric Box	01592092	1
29	Electric Box Cover 2	20112081	1
30	Electric Box Assy	01397320	1
31	Evaporator Angular	24212100	1
32	Pipe Connection Assembly	06649591	2
33	Blow Molding Drainage Pipe	05230022	1

Notes:

① only is part of FP-68BA3/B-K.

Spare parts list:
FP-85BA3/B-K (EM55001740)

No.	Name of part	Part code	Quantity
1	Front Panel Assy	20012260 ① 20012283 ② 20012286 ③	1
2	Filter Sub-Assy	1112208901	2
3	Front Case	2690603901	1
4	Screw Cover	24252016	1
5	Rubber Plug (Water Tray)	76712012	1
6	Surface Cooler Assy	01127666	1
7	Cross Flow Fan	10352019	1
8	Ring of Bearing	76512051	1
9	Rear Case assy	1231221408	1
10	Wall Mounting Frame	01252218	1
11	Volute tongue	26112238	1
12	Air Louver 1	10512116	1
13	Axile Bush	10542036	1
14	Left Axile Bush	10512037	1
15	Guide Louver	10512115	1
16	Crank	10582070	1
17	Stepping Motor	15012086	1
18	Swing Louver2	10512117	1
19	Drainage hose	05230014	1
20	Rear Clamp	26112164	1
21	Motor	15706433	1
22	Motor Press Plate	26112494	1
23	Electric Box	20112108	1
24	Capacitor	33010020	1
25	Installation Supporting Frame	01806867	1
26	Terminal Board	42010262	1
27	Electric Box Cover 1	20122154	1
28	Shield cover of Electric Box	01592092	1
29	Electric Box Cover 2	20112081	1
30	Electric Box Assy	01397320	1
31	Evaporator Angular	24212100	1
32	Pipe Connection Assembly	06649591	2
33	Blow Molding Drainage Pipe	05230022	1

Notes:

① only is part of FP-85BA3/B-K.

Model:FP-68BA2/A-K(EM55000220), FP-85BA2/A-K(EM55000230), FP-68BA3/A-K(EM55001290), FP-85BA3/A-K(EM55001360), FP-68BA4/A-K(EM55001300), FP-85BA4/A-K(EM55001370), FP-68BA5/A-K(EM55000280), FP-85BA5/A-K(EM55000290), FP-68BB3/A-K(EM55001340), FP-85BB3/A-K(EM55001410), FP-85BA2/A-D(EM55001590) , FP-68BA2/D-K(EM55001830), FP-85BA2/D-K(EM55001840), FP-68BA3/D-K(EM55002020), FP-85BA3/D-K(EM55002030), FP-68BA4/D-K(EM55002060), FP-85BA4/D-K(EM55002060), FP-68BA5/D-K(EM55002100), FP-85BA5/D-K(EM55002110), FP-68BA2/D-K(E)(EM55002450), FP-68BA3/D-K(E)(EM55002460), FP-68BA4/D-K(E)(EM55002470), FP-68BA5/D-K(E)(EM55002480), FP-85BA2/D-K(E)(EM55002490), FP-85BA3/D-K(E)(EM55002500), FP-85BA4/D-K(E)(EM55002510), FP-85BA5/D-K(E)(EM55002520)

Exploded Views:

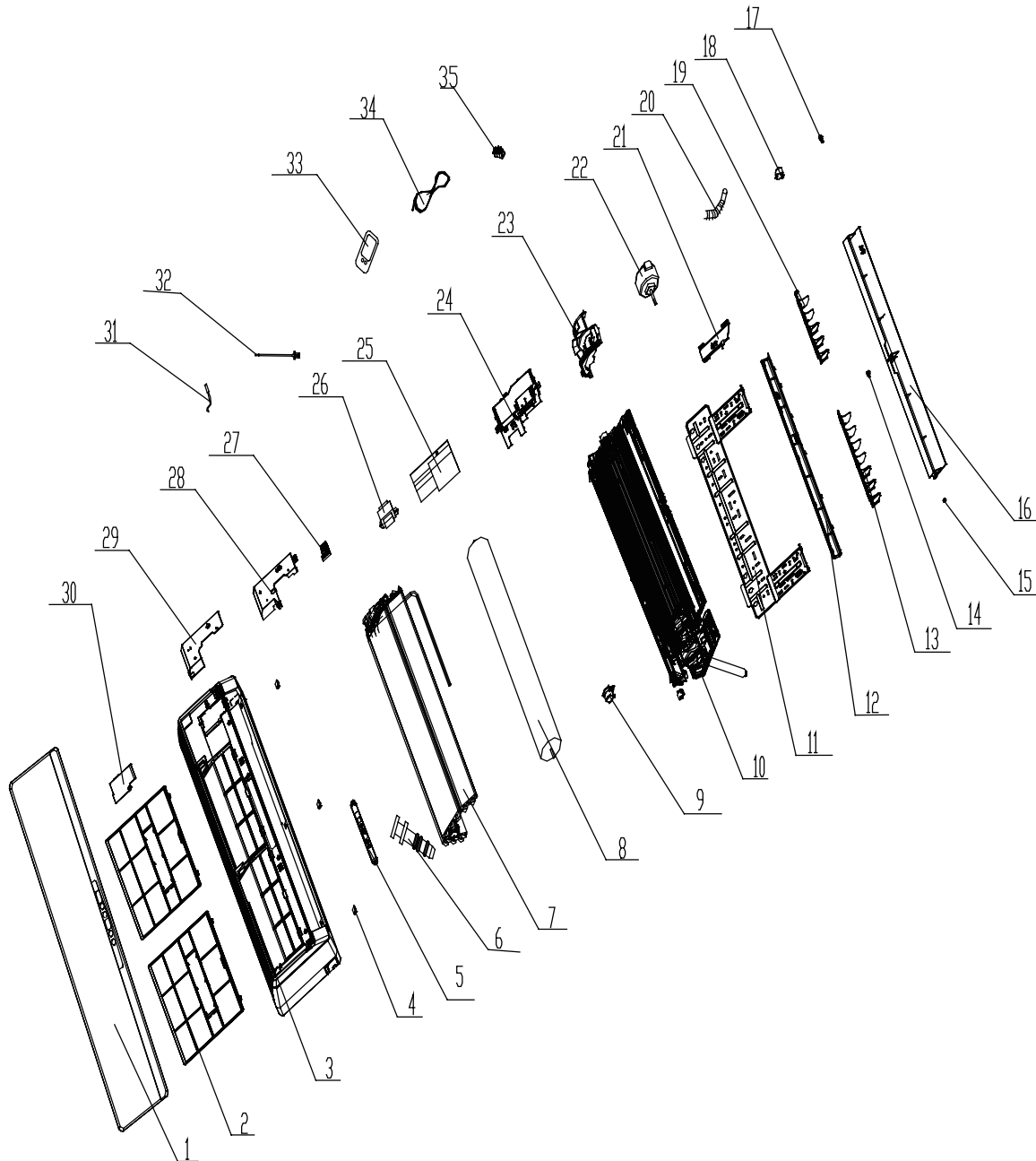

Spare parts list:

FP-68BA2/A-K (EM55000220), FP-85BA2/A-K (EM55000230), FP-68BA3/A-K (EM55001290), FP-85BA3/A-K (EM55001360), FP-68BA4/A-K (EM55001300), FP-85BA4/A-K (EM55001370), FP-68BA5/A-K (EM55000280), FP-85BA5/A-K (EM55000290), FP-68BB3/A-K (EM55001340), FP-85BB3/A-K (EM55001410), FP-85BA2/A-D(EM55001590), FP-68BA2/D-K (EM55001830), FP-85BA2/D-K (EM55001840).FP-68BA2/D-K(E)(EM55002450), FP-68BA3/D-K(E)(EM55002460), FP-68BA4/D-K(E)(EM55002470), FP-68BA5/D-K(E)(EM55002480), FP-85BA2/D-K(E)(EM55002490), FP-85BA3/D-K(E)(EM55002500), FP-85BA4/D-K(E)(EM55002510), FP-85BA5/D-K(E) (EM55002520).

No.	Name of part	Part code	Quantity	No.	Name of part	Part code	Quantity
1	Front Panel Assy	20012283 ① ② ⑨	1	19	Air Louver 2	10512117	1
		20012260 ③ ④					
		20012280 ⑤ ⑥					
		20012286 ⑦ ⑧ 20012467 ⑩ ⑪					
2	Filter Sub-Assy	1112208901	2	20	Drainage hose	05230014	1
3	Front Case	20012250	1	21	Pipe Clamp	26112164	1
4	Screw Cover	24252016	1	22	Fan Motor	15012116 ① ② ③ ④ ⑤ ⑥ ⑦ ⑧ ⑩ ⑪	1
						1501211601 ⑨	
5	Display Board	30565039 ① ② ⑤ ⑥ ⑨	1	23	Motor Press Plate	26112178	1
		30565038 ③ ④					
		30565038 ⑦ ⑧					
		30565037 ⑩ ⑪					
6	Rubber Plug (Water Tray)	76712012	1	24	Electric Box	20112108	1
7	Evaporator Assy	24212100	1	25	Main Board	30225045	1
8	Cross Flow Fan	10352019	1	26	Transformer	43110237	1
9	Ring of Bearing	26152022	1	27	Terminal Board	42010268	1
10	Rear Case Assy	12312214	1	28	Electric Box Cover1	20122128	1
11	Wall Mounting Frame	01252218	1	29	Shield cover of Electric Box	01592092	1
12	Helicoid tongue	26112238	1	30	Electric Box Cover2	20112081	1
13	Air Louver 1	10512116	1	31	Tube Sensor	390000592	1
14	Axile Bush	10542008	1	32	Ambient Temperature Sensor	390000451	1
15	Left Axile Bush	10512037	1	33	Remote Controller	30510041	1
16	Guide Louver	10512115	1	34	Power Cord	400220112	1
17	crank	10582070	1	35	Jumping Connector	4202300126 ① ③ ⑤ ⑦ ⑩	1
18	Step Motor	15012086	1			4202300120 ② ④ ⑥ ⑧ ⑨ ⑪	

Note:

① is part of FP-68BA2/A-K, FP-68BA2/D-K, FP-68BA2/D-K(E) ; ② is part of FP-85BA2/A-K, FP-85BA2/D-K, FP-85BA2/D-K(E) ; ③ is part of FP-68BA3/A-K, FP-68BA3/D-K, FP-68BA3/D-K(E) ; ④ is part of FP-85BA3/A-K, FP-85BA3/D-K, FP-85BA3/D-K(E) ; ⑤ is part of FP-68BA4/A-K , FP-68BA4/D-K, FP-68BA4/D-K(E) ; ⑥ is part of FP-85BA4/A-K, FP-85BA4/D-K, FP-85BA4/D-K(E) ; ⑦ is part of FP-68BA5/A-K, FP-68BA5/D-K, FP-68BA5/D-K(E) ; ⑧ is part of FP-85BA5/A-K, FP-85BA5/D-K, FP-85BA5/D-K(E) ; ⑨ is part of FP-85BA2/A-D ; ⑩ is part of FP-68BB3/A-K, ⑪ is part of FP-85BB3/A-K.

Model: FP-85BWA2/A-K(E) (EM55002340), FP-85BWA3/A-K(E) (EM55002350).

Exploded Views:

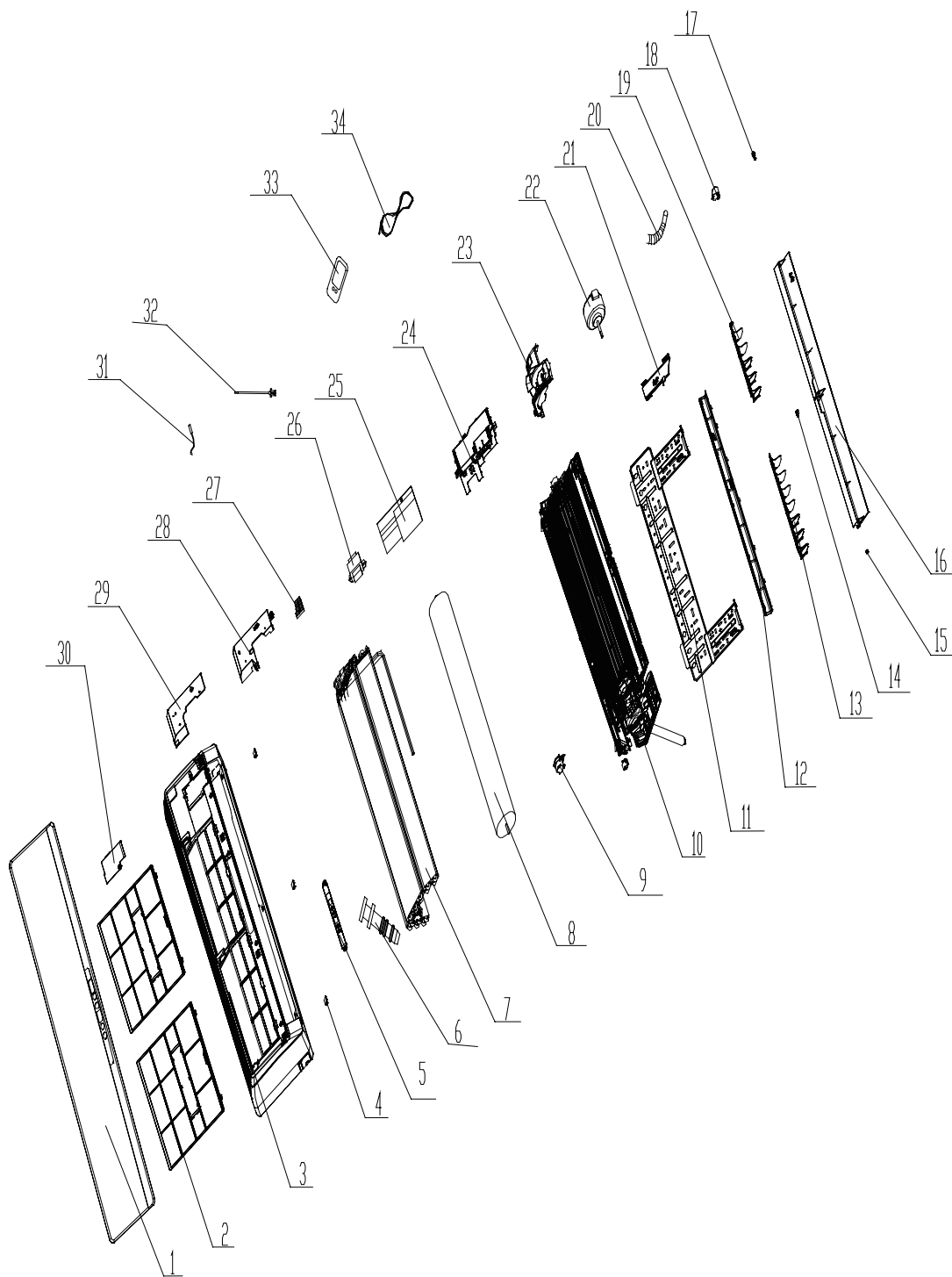

Spare parts list:

FP-85BWA2/A-K(E) (EM55002340), FP-85BWA3/A-K(E)(EM55002350)

No.	Name of part	Part code	Quantity	No.	Name of part	Part code	Quantity
1	Front Panel Assy	20012283 ① 20012286 ②	1	18	Stepping Motor	15012086	1
2	Filter Sub-Assy	1112208901	2	19	Air Louver 2	10512117	1
3	Front Case	20012250	1	20	Drainage hose	05230014	1
4	Screw Cover	24252016	1	21	Pipe Clamp	26112164	1
5	Display Board	30565039 ① 30565038 ②	1	22	Fan Motor	15012113 ① 15012116 ②	1
6	Rubber Plug (Water Tray)	76712012	1	23	Motor Press Plate	26112178	1
7	Evaporator Assy	24212100	1	24	Electric Box	20112108	1
8	Cross Flow Fan	10352019	1	25	Main Board	30225045	1
9	Ring of Bearing	26152022	1	26	Transformer	43110237	1
10	Rear Case Assy	12312214	1	27	Terminal Board	42010268	1
11	Wall Mounting Frame	01252218	1	28	Electric Box Cover1	20122128	1
12	Helicoid tongue	26112238	1	29	Shield cover of Electric Box	01592092	1
13	Air Louver 1	10512116	1	30	Electric Box Cover2	20112081	1
14	Axile Bush	10542008	1	31	Tube Sensor	390000592	1
15	Left Axile Bush	10512037	1	32	Ambient Temperature Sensor	390000451	1
16	Guide Louver	10512115	1	33	Remote Controller	30510041	1
17	crank	10582070	1	34	Power Cord	400220112	1

Note:

① is part of FP-85BWA2/A-K(E) only.

② is part of FP-85BWA3/A-K(E) only.

Model: FP-34BA2/B-D (EM55000320), FP-51BA2/B-D (EM55000330), FP-34BA3/B-D(EM55001760), FP-51BA3/B-D(EM55001800), FP-34BA5/B-D(EM55001890), FP-51BA5/B-D(EM55001900)

Exploded Views:

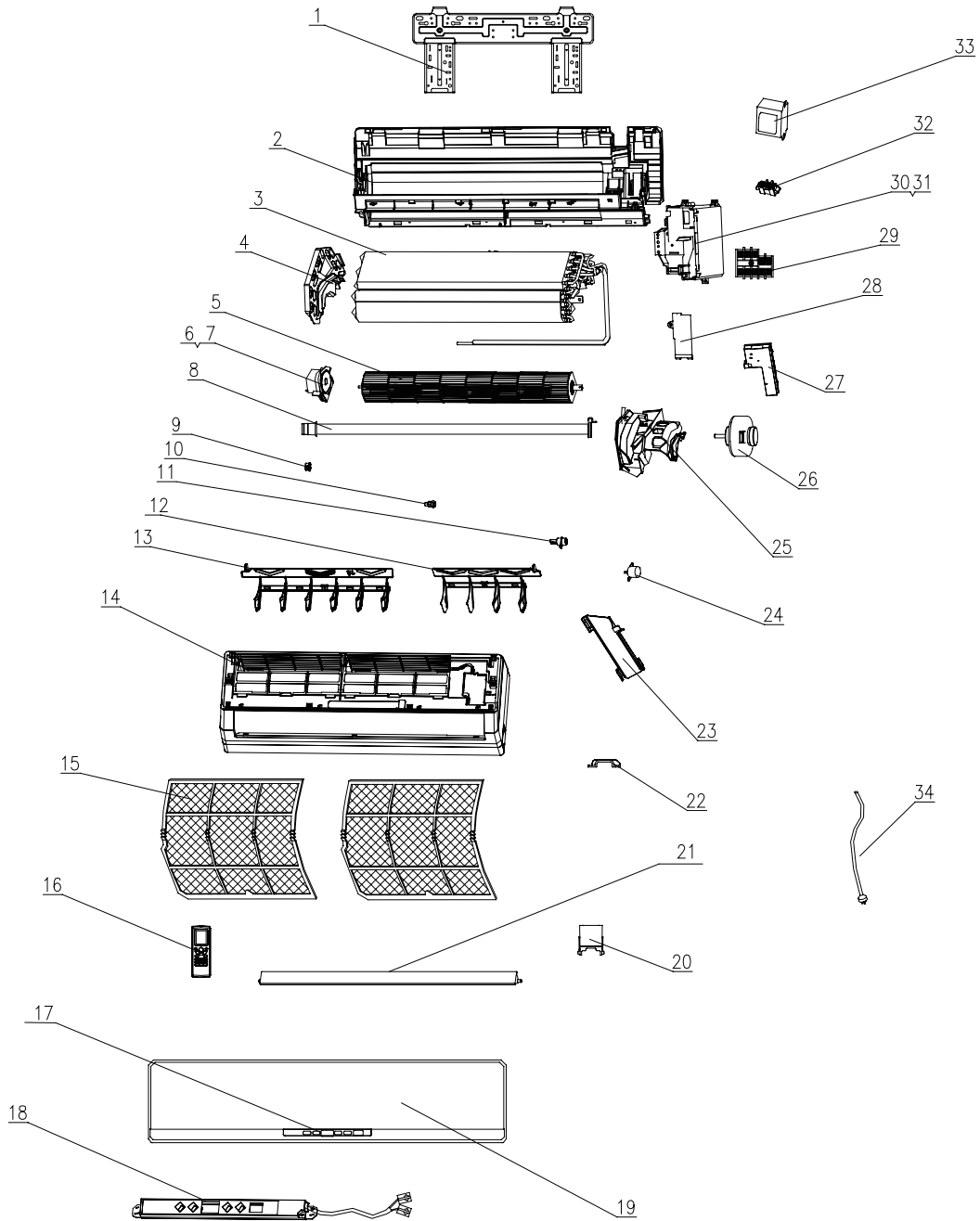

Spare parts list:

FP-34BA2/B-D (EM55000320), FP-51BA2/B-D (EM55000330), FP-34BA3/B-D(EM55001760), FP-51BA3/B-D(EM55001800), FP-34BA5/B-D(EM55001890), FP-51BA5/B-D(EM55001900)

No.	Name of part	Part code	Quantity
1	Wall-Mounting Frame	01252013 ①②③④ 01252021 ⑤⑥	1
2	Rear Case	2220245401	1
3	Sufer Cooler Assy	01126406	1
4	Evaporator Support	24212091	1
5	Cross Flow Fan	10352017	1
6	Ring of Bearing	26152022	1
7	Bearing cushion rubber base	76512203	1
8	Volute tongue	26112163	1
9	Left Axile Bush	10512037	1
10	Crank	10582070	1
11	Axile Bush	10542008 ①②③④ 10542036 ⑤⑥	1
12	Swing Louver1	10512156	1
13	Swing Louver2	10512155	1
14	Front Case	20012123	1
15	Filter	1112220401 ①②③④ 1112208503 ⑤⑥	2
16	Remote Control YBIFA(XFAN)	30510516	1
17	Decorative Board	20192265 ①②④ 22432230 ③ 20192247 ⑤⑥	1
18	Display Board	30565056 ①④ 30565007 ②③	1
19	Front Panel	20012150S ①②③④ 20012199S ⑤⑥	1
20	Screw Cover	24252016	1
21	Guide Louver	10512157	1
22	Wire Clamp	71010003	1
23	Rear Clamp	26112164	1
24	Motor MP24AA	1521212901	1
25	Motor Clamp	26112161	1
26	Motor FN20X-PG	15012089	1
27	Electric Box Cover 1	20122103	1
28	Covering Plate2	20122075	1
29	Terminal Board	42010262	1
30	Electric Box	2011208201	1
31	Main Board	30225043	1
32	Jumping Connector	4202300117 ① 4202300125 ②④ 4202300117 ③⑤⑥	1
33	Transformer 48X26G	43110233	1
34	Power Cord	4002048712	1

Note:

- ① only is part of FP-34BA2/B-D
- ② only is part of FP-34BA3/B-D
- ③ only is part of FP-51BA3/B-D
- ④ only is part of FP-51BA2/B-D

⑤ only is part of FP-34BA5/B-D

⑥ only is part of FP-51BA5/B-D

Model: FP-68BA2/B-D (EM55000340), FP-85BA2/B-D (EM55000350), FP-102BA2/B-D (EM55000360),
FP-68BA3/B-D(EM55001770), FP-85BA3/B-D(EM55001780), FP-102BA3/B-D(EM55001790), FP-68BA5/B-D
(EM55001910) , FP-85BA5/B-D (EM55001920) , FP-102BA5/B-D (EM55001930).

Exploded Views:

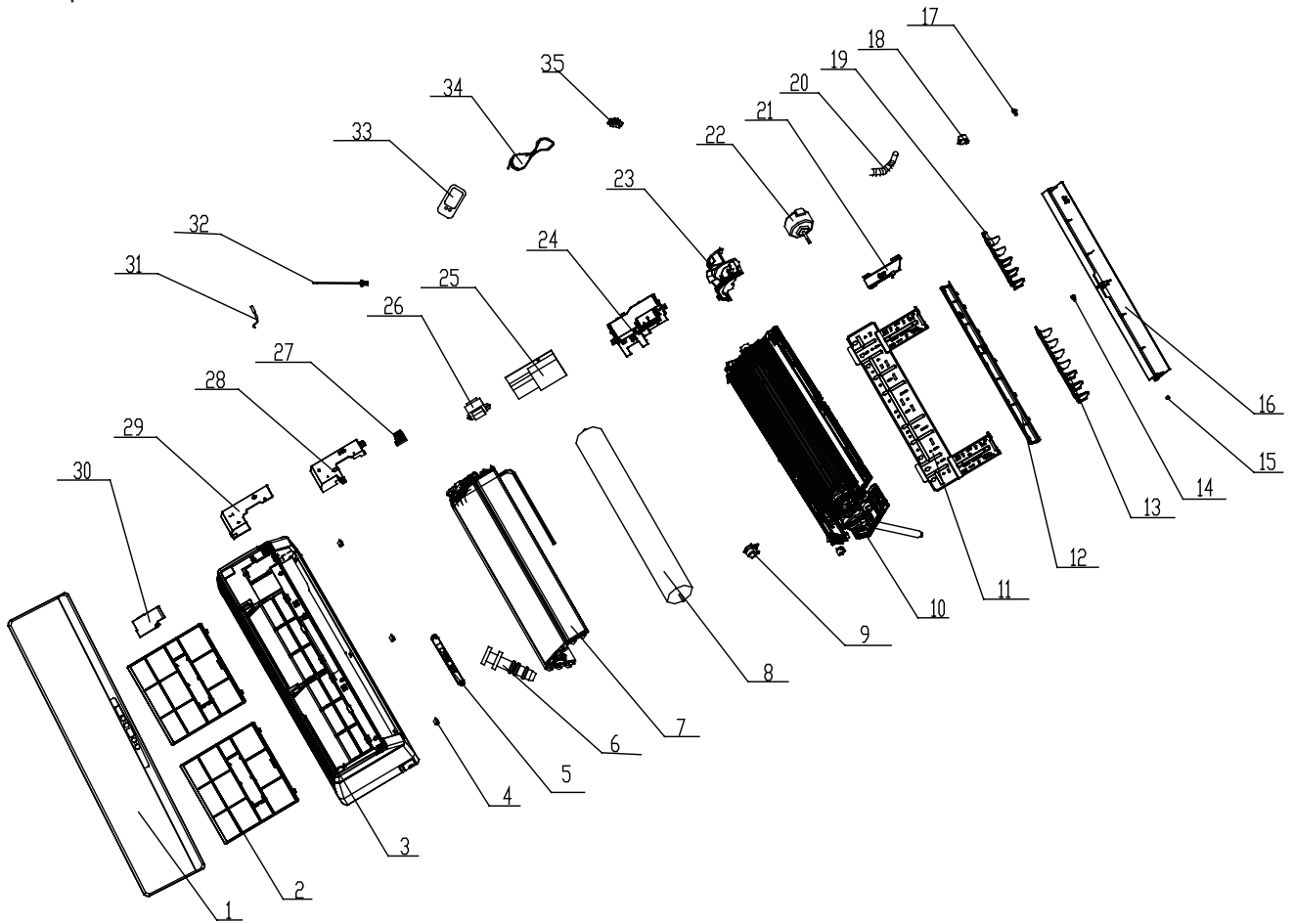

Spare parts List:

FP-68BA2/B-D (EM55000340), FP-85BA2/B-D (EM55000350), FP-102BA2/B-D (EM55000360), FP-68BA3/B-D(EM55001770), FP-85BA3/B-D(EM55001780), FP-102BA3/B-D(EM55001790), FP-68BA5/B-D (EM55001910), FP-85BA5/B-D (EM55001920), FP-102BA5/B-D (EM55001930)

No.	Name of part	Part code	Quantity
1	Front Panel Assy	2001216801 ①②③ 20012260 ④⑤⑥ 20012286 ⑦⑧⑨	1
2	Filter Sub-Assy	1112208901	2
3	Front Case	20012261S ①②③④⑤⑥ 20012271S ⑦⑧⑨	1
4	Screw Cover	24252016	1
5	Display Board	30565039 ①②③④⑤⑥ 30565038 ⑦⑧⑨	1
6	Rubber Plug (Water Tray)	76712012	1
7	Surface Cooler Sub-Assy	01126648 ① 01126649 ② 01126405 ③ 01126649 ④⑤ 01126405 ⑥ 01156558 ⑦⑧⑨	1
8	Cross Flow Fan	10352019	1
9	Ring of Bearing	26152022	1
10	Rear Case assy	1231221408	1
11	Wall Mounting Frame	01252218	1
12	Helicoid tongue	26112238	1
13	Air Louver 1	10512116	1
14	Axile Bush	10542036	1
15	Left Axile Bush	10512037	1
16	Guide Louver	10512115	1
17	Crank	10582070	1
18	Stepping Motor	15012086	1
19	Air Louver 2	10512117	1
20	Drainage Hose	05230014	1
21	Pipe Clamp	26112164	1
22	Fan Motor FN20W-PG	1501211601	1
23	Motor Press Plate	26112494	1
24	Electric Box	20112108	1
25	Main Board	3022504501	1
26	Transformer	43110237	1
27	Terminal Board	42010268	1
28	Electric Box Cover1	20122154	1
29	Shield cover of Electric Box	01592091	1
30	Electric Box Cover2	20112081	1
31	Tube Sensor	05212423	1
32	Ambient Temperature Sensor	390000592	1
33	Remote ControlYB1FA(XFAN)	30510516	1
34	Power Cord	4002048712	1
35	Jumping Connector	4202300126 ①④⑦⑧⑨ 4202300111 ② 4202300120 ③⑥ 4202300127 ⑤	1

Notes:

- ① only is part of FP-68BA2/B-D
- ② only is part of FP-85BA2/B-D
- ③ only is part of FP-102BA2/B-D
- ④ only is part of FP-68BA3/B-D
- ⑤ only is part of FP-85BA3/B-D
- ⑥ only is part of FP-102BA3/B-D
- ⑦ only is part of FP-68BA5/B-D
- ⑧ only is part of FP-85BA5/B-D
- ⑨ only is part of FP-102BA5/B-D

Model: FP-51BWA3/A-K(E) (EM55002320)

Eploded views:

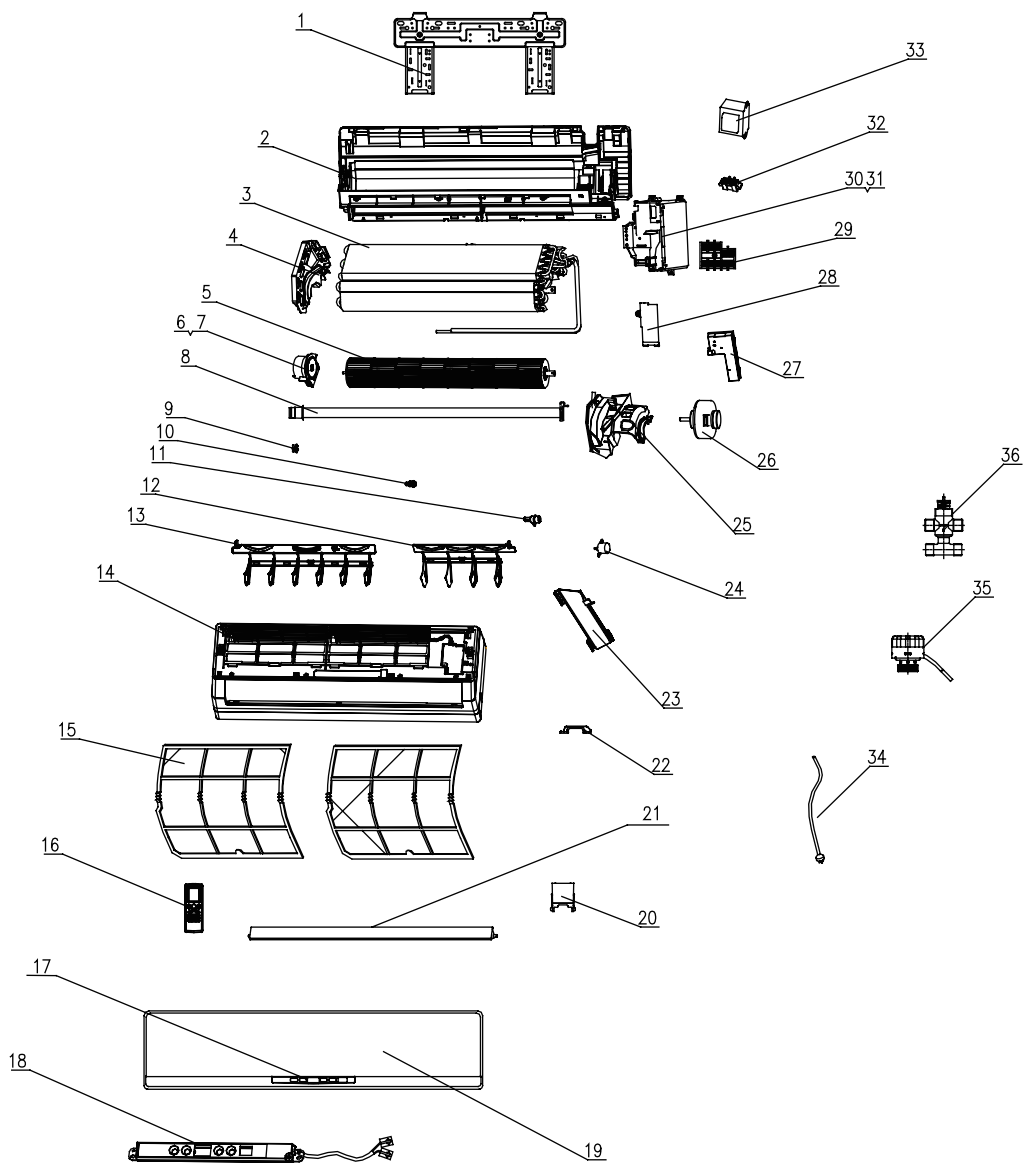

Spare parts List:
FP-51BWA3/A-K(E) (EM55002320)

No.	Name of part	Part code	Quantity
1	Wall-Mounting Frame	01252021	1
2	Rear Case	2220245401	1
3	Sufer Cooler Assy	01126407	1
4	Evaporator Support	24212091	1
5	Cross Flow Fan	10454101	1
6	Ring of Bearing	26152022	1
7	Bearing cushion rubber base	76512203	1
8	Volute tongue	26112163	1
9	Left Axile Bush	10512037	1
10	Crank	10582070	1
11	Axile Bush	10542036	1
12	Swing Louver1	10512156	1
13	Swing Louver2	10512155	1
14	Front Case	26906038	1
15	Filter	1112220401	2
16	Remote Control YB1FA	30510516	1
17	Decorate Piece	22432230	1
18	Display Board D5183Z	30565007	1
19	Front Panel	20012123	1
20	Screw Cover	24252016	1
21	Guide Louver	10512157	1
22	Wire Clamp	22432230	1
23	Rear Clamp	26112164	1
24	Motor MP24AA	1521212901	1
25	Motor Clamp	26112161	1
26	Motor FN20J-PG	150120874	1
27	Electric Box Cover 1	20122103	1
28	Covering Plate2	20122075	1
29	Terminal Board	42010262	1
30	Electric Box	2011208201	1
31	Main PCB Z5P251A	30225043	1
32	Jumping Connector	4202300127	1
33	Transformer 48X26G	43110233	1
34	Power Cable	400220112	1
35	Loop of electromagnetic valve	43007002	1
36	Electromagnetic valve	43007001	1

Model: FP-85BWA3/A-K(E) (EM55002350)

Exploded views:

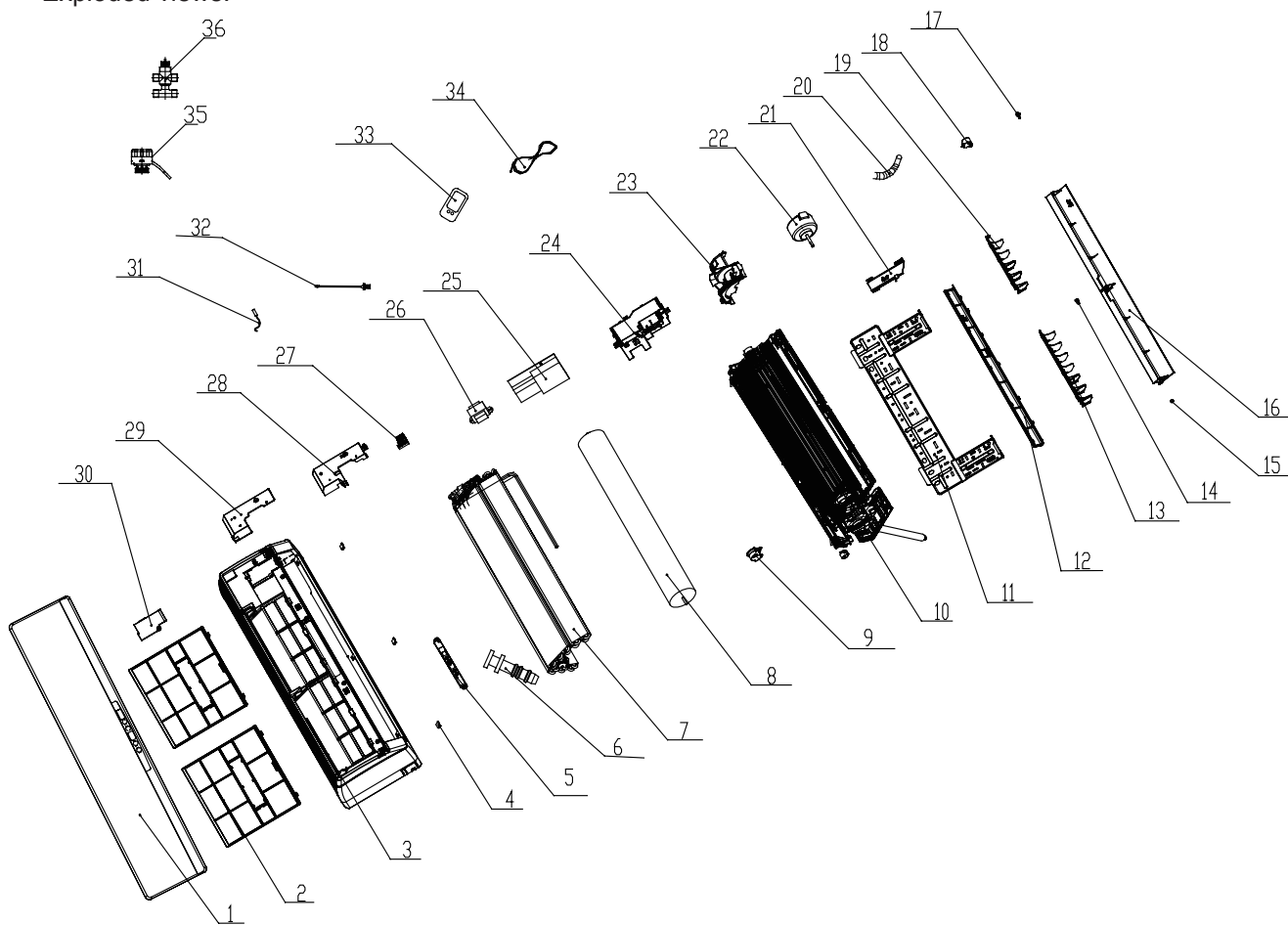

Spare parts List:
FP-85BWA3/A-K(E) (EM55002350)

No.	Name of part	Part code	Quantity
1	Front Panel Assy	20012260	1
2	Filter Sub-Assy	1112208901	2
3	Front Case	26906039	1
4	Screw Cover	24252016	3
5	Display Board	30565038	1
6	Rubber Plug (Water Tray)	76712012	1
7	Surface-Cooler Assy	01126404	1
8	Cross Flow Fan	10454102	1
9	Ring of Bearing	26152022	1
10	Rear Case assy	01516005	1
11	Wall Mounting Frame	01252218	1
12	Helicoid Tongue	26112238	1
13	Air Louver 1	10512116	1
14	Axile Bush	10542036	1
15	Left Axile Bush	10512037	1
16	Guide Louver	10512115	1
17	Crank	10582070	1
18	Motor	15012086	1
19	Air Louver 2	10512117	1
20	Drainage Hose	05230014	1
21	Pipe Clamp	26112164	1
22	Fan Motor	15012116	1
23	Motor Clamp	26112494	1
24	Electric Box	20112108	1
25	Main Board	3022504501	1
26	Transformer	43110237	1
27	Terminal Board	42010268	1
28	Electric Box Cover1	20122154	1
29	Shield Cover of Electric Box	01592092	1
30	Electric Box Cover 2	20112081	1
31	Tube Sensor	390000592G	1
32	Temperature Sensor	390000451	1
33	Remote Controller	30510516	1
34	Power Cord	400220112	1
35	Loop of electromagnetic Valve	43007002	1
36	Electromagnetic Valve	43007001	1

Model: FPD-34BB3/A-K(EM55002580), FPD-51BB3A-K(EM55002600), FPD-68BB3A-K(EM55002590)
Exploded views:

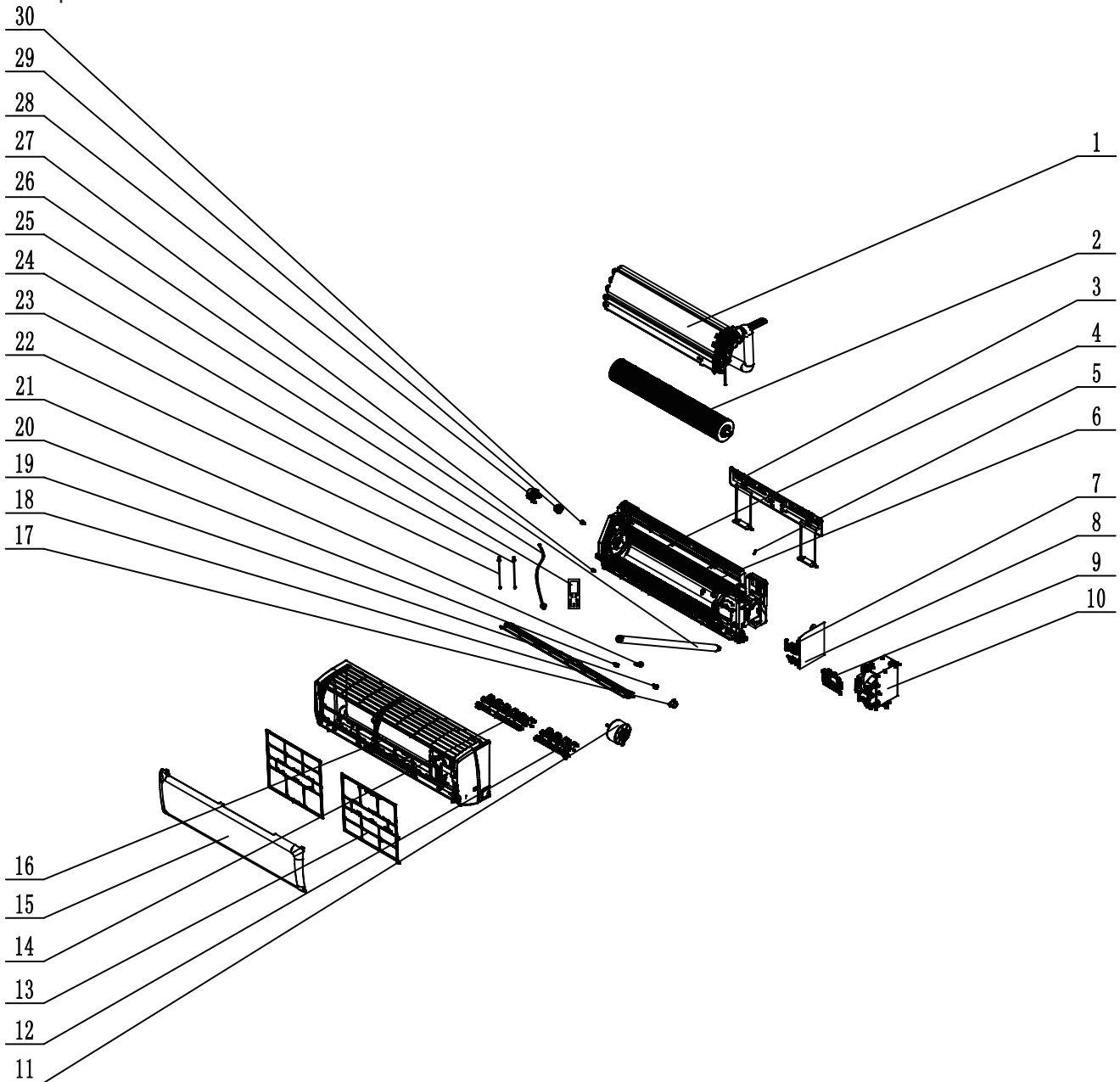

Spare parts List:

FPD-34BB3/A-K(EM55002580), FPD-51BB3A-K(EM55002600), FPD-68BB3A-K(EM55002590)

No.	Surface-Cooler Assy	Part code	Quantity
1	Cross Flow Fan	011005060416	1
2	Wall Mounting Frame	10352056	1
3	Stainless steel clasp	01252484	1
4	Sensor Insert	02112469	3
5	Rear Case assy	42020063	1
6	Terminal Board	000001060060	1
7	Main Board	42010268	1
8	Display Board	300002061035	1
9	Electric Box Assy	30565260	1
10	Fan Motor	100002067093	1
11	Air Louver 2	1501246601	1
12	Filter Sub-Assy	10512724	1
13	Air Louver 1	11122468	2
14	Front Panel	10512723	1
15	Front Case Assy	20000300027T	1
16	Stepping Motor	00000200045	1
17	Guide Louver	1521210710	1
18	Crank	1051293101	1
19	Axile Bush	73012005	1
20	Rubber Plug (Water Tray)	10542036	1
21	Temperature Sensor	76712012	1
22	Temperature Sensor	390000454	1
23	Remote Controller	390000596	1
24	Power Cord	30510589	1
25	Drainage Hose	4002046417	1
26	Left Axile Bush	05230014	1
27	Ring of Bearing	10512037	1
28	O-Gasket of Cross Fan Bearing	26152022	1
29	Fan Bearing	76512203	1
30	Electric Box Cover2	7651221001	1

Model: FPD-85BB3/A-K(EM55002610)

Exploded views:

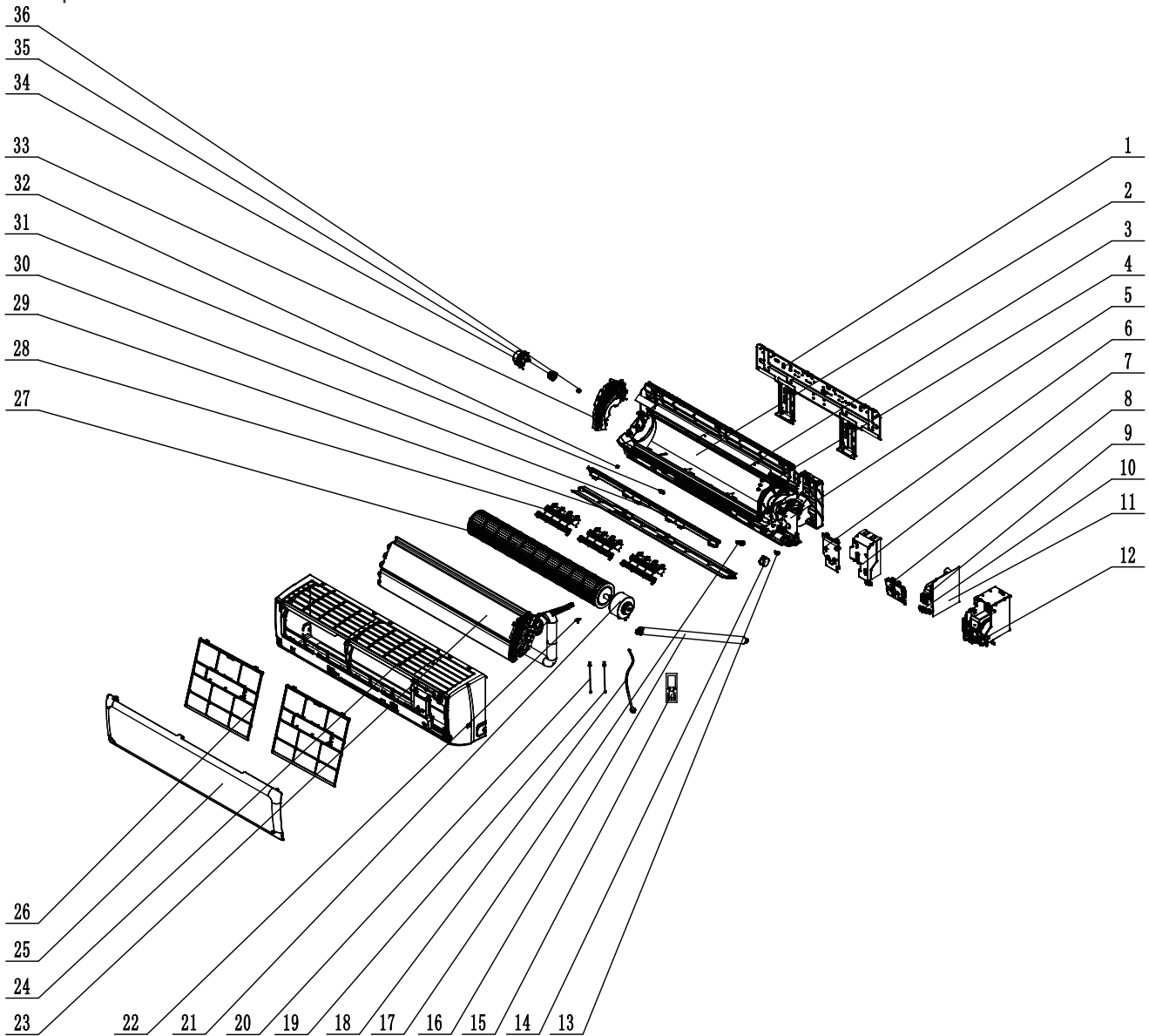

Spare parts List: FPD-85BB3/A-K(EM55002610)

No.	Name of part	Part code	Quantity
1	Wall Mounting Frame	01362026	1
2	Rear Case	22202717	1
3	Stainless steel clasp	02112469	3
4	Sensor Insert	42020063	1
5	Shield Cover of Electric Box Cover 2	01202000099	1
6	Electric Box Cover2	20112210	1
7	Shield Cover of Electric Box Cover	01592176	1
8	Display Board	30565260	1
9	Terminal Board	42010268	1
10	Cable Clamp 2	71012065	1
11	Main Board	300002061035	1
12	Electric Box	2011221105	1
13	Crank	73012005	1
14	Stepping Motor	1521240212	1
15	Remote Controller	30510589	1
16	Drainage Hose	05230014	1
17	Rubber Plug (Water Tray)	76712012	1
18	Power Cord	4002046417	1
19	Temperature Sensor	390000454	1
20	Temperature Sensor	390000596	1
21	Fan Motor	15012136	1
22	Air relief valve core	07336000028	1
23	Surface-Cooler Assy	011005060419	1
24	Front Case Assy	00000200042	1
25	Front Panel	20000300028	1
26	Filter Sub-Assy	1112208906	2
27	Cross Flow Fan	10352060	1
28	Air Louver(Manual)	10512732	3
29	Guide Louver	1051276501	1
30	Helicoid Tongue	26112512	1
31	Axile Bush	10542036	2
32	Left Axile Bush	10512037	1
33	Evaporator Support	24212177	1
34	Ring of Bearing	26152025	1
35	O-Gasket of Cross Fan Bearing	76512203	1
36	Fan Bearing	7651221001	1



JF00300236

GREE ELECTRIC APPLIANCES, INC. OF ZHUHAI

Add: West Jinji Rd, Qianshan, Zhuhai, Guangdong, China, 519070

Tel: (+86-756) 8522218 Fax: (+86-756) 8669426

E-mail: gree@gree.com.cn www.gree.com

For continuous improvement in the products, Gree reserves the right to modify the product specification and appearance in this manual without notice and without incurring any obligations.